



**ELECTRIC • PNEUMATIC
HYDRAULIC • GAS**
...the power of innovation!®

Contractor Tools

for Concrete, Masonry, Steel, Stone and more



Surface Preparation Tools
Concrete Grinders
Dust Collection Systems
Diamond Core Drills
Concrete Diamond Saws
Portable Mixing Machines
Underwater & Specialty Tools

A red portable mixing machine with a black frame and wheels, featuring the 'PORTAMIX' logo in white. It has a hopper on top and a mixing chamber below.

Concrete Surface Preparation

Concrete Surface Profile (CSP)

Concrete Surface Profile (CSP) is the measurement of the peaks and troughs in the surface. CSP standards are rated from 1 (smoothest) to 10 (roughest). Measured in Microns/Mils, CSP is an important consideration when preparing concrete surfaces to most effectively bond with concrete overlays and coatings. To achieve the desired CSP, it is important to select the correct surface preparation equipment for your application.

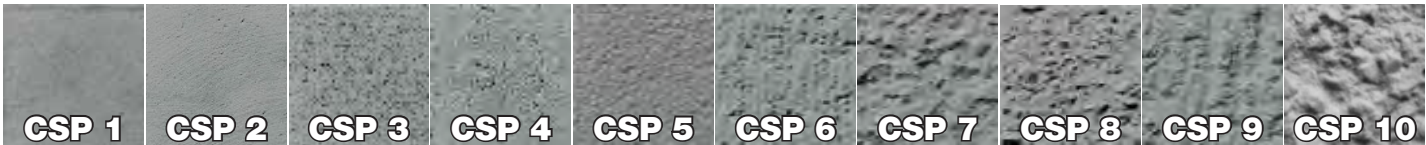
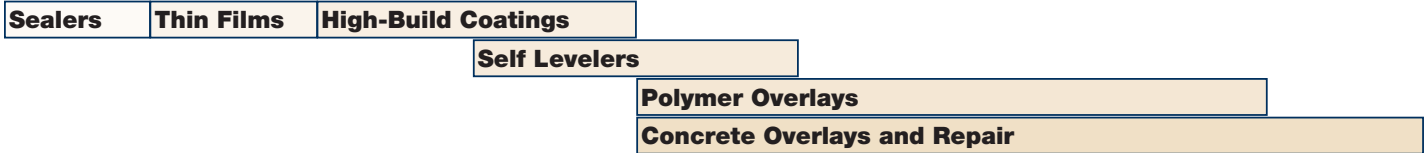
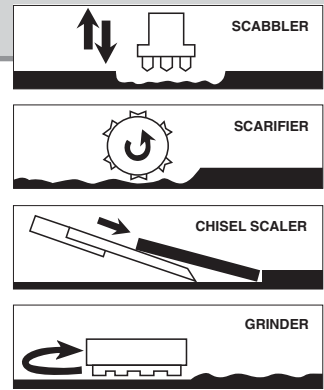

Surface Preparation Tools & Dust Collection Vacuums



CS Unitec's Trelawny™ line of surface preparation tools features many Vibro-Lo™ models with integrated vibration reduction technology to operate with 8x less vibration than standard models. Vibration damping components offset the hammer vibration when the tool impacts the workpiece, reducing the risk of vibration-related injury.



Trelawny™ tool and vacuum system (TVS™) range of products has been designed specifically to ensure the recovery of lead based paint, radioactive contaminants and other hazardous and non-hazardous materials from the source of surface preparation equipment and hand tools, which helps to provide a safer, cleaner working environment.



Hand-Held Scabblers	p. 4-5	Pneumatic Needle/Chisel Scalers	p. 12-18
Standard	p. 4	Heavy-Duty Needle/Chisel Scalers	p. 12-13
Heavy-duty	p. 5	TVS™ Vacuum-Shroud Needle Scalers	p. 12
Floor Scabblers	p. 6-7	Low-Vibration Needle Scalers	p. 14-15
MHS11 (11-Head)	p. 6	Low-Vibration Chisel Scalers	p. 14, 16
MHS5 (5-Head)	p. 7	ATEX Needle/Chisel Scalers	p. 17
Pole Scabblers/Tampers	p. 8	Needles	p. 18
Hand-Held Scarifiers – Rotopeen™	p. 9	Long-Reach Chisels/Scrapers/Scalers	p.19
Floor Scarifiers (Gas • Electric • Air)	p. 10-11	Dust Collection Systems and Vacuums	p. 20-21
TFP 200 (8" Cutting Width)	p.10	Concrete Grinding Machines	p. 22-23
TFP 260 (10" Cutting Width)	p. 11	Hand-Held & Floor (Electric)	p. 22
		Floor (Electric • Gas)	p. 23
		Surface Milling Machine	p. 24
		Scouring and Scarifying Machine	p. 24
		Plaster Smoothing Machine	p. 24



Concrete and Masonry Tools

Core Drilling, Mixing, Sawing and More

Wet/Dry Diamond Core Drills

- Electric
- Hydraulic and Air
- Drill Stands and Rigs

p. 25-28

- p. 25-26
- p. 27
- p. 28

Concrete Saws

- Chain Saws (Air • Hydraulic)
- Cut-Off: Hand-Held and Walk-Behind (Air)

p. 29-30

p. 29

p. 30

Rotary Hammer Drills

p. 31

Wet/Dry Stone Saw

p. 32

Wall Slotter

p. 32

Diamond Saw for Tile and Stone

p. 33

Mixing Drills and Paddles

p. 34-35

Portable Mixing Stations with Dust Control

p. 36-39

- MEGA HIPPO Mixing System
- Pelican Transport Cart
- Pelican Mixing Station
- TwinMix Automatic Mixing Station

p. 36-37

p. 37

p. 38

p. 39

Underwater and Specialty Tools

p. 40-51

- Reciprocating Saws (Air •Hydraulic)
- Hacksaws (Air •Hydraulic)
- Band Saws (Air •Hydraulic)
- Pipe Cutting Machines (Air •Hydraulic)
- Chain Saws (Air)
- Chain Saw Bars and Chains
- Chain Saws (Air • Hydraulic)
- Magnetic Drills (Air • Hydraulic)
- Rotary Hammer Drills (Air •Hydraulic)
- Woodboring Drills (Air)
- Metal & Concrete Circular Saws (Air)
- Metal & Concrete Circular Saws (Hydraulic)
- Diamond Core Drills (Hydraulic • Air)
- Impact Wrenches (Air • Hydraulic)
- Grinders (Hydraulic)
- Hydraulic Power Unit
- AirPac Air Tool Dryer/Cleaner
- Air Tool Service Unit/Lubricator

p. 40

p. 41

p. 42

p. 43

p. 44

p. 44

p. 45

p. 46

p. 47

p. 47

p. 48

p. 49

p. 50

p. 50

p. 51

p. 51

p. 51

p. 51



Roughen, reduce and level concrete; prepare surfaces for coatings and finishes

CS Unitec's Trelawny™ line of pneumatic hand-held construction scabblers are ideal for roughing and reducing concrete surfaces to remove laitance and coatings and expose aggregate to allow for proper application of new materials such as textured finishes and waterproofing coatings.

- Single-head scabbler includes integrated Vibro-Lo™ vibration reduction technology
- Triple scabbler includes integrated back handle grip for comfortable operation and control
- Single-piece Tungsten Carbide Tipped pistons with Cruciform or Bush heads

Applications include:

- Scabbling concrete to expose aggregate
- Leveling concrete and block joints
- Texturing, roughing and reducing concrete
- Preparing for coatings and waterproofing compounds
- Bridge maintenance

Scabbling Hammer Accessories

	Part No.	For Model Numbers
Single-Piece Cruciform Piston	612.6000	151.6170 and 153.6150
Single-Piece Bush Piston	612.6010	151.6171 and 153.6151
Whip Check	815.5550	
Lubricators	859.1555	151.6171 and 151.6170 153.6151 and 153.6150



Bush

Bush Heads: Ideal for laitance removal, roughening concrete for resurfacing and preparing construction joints. Leaves a heavy pitted profile.



Cruciform

Cruciform Heads: Ideal for removing laitance & coatings, cruciform heads cut through material leaving a flatter finish and profile than bush heads



Pneumatic

Triple Scabbler includes integrated back handle grip for operator comfort and control.



CS Unitec's Trelawny™ Vibro-Lo™ Single-Head Scabbler operates with 60% less vibration than standard models. This tool utilizes vibration damping components to offset the hammer vibration created when the head impacts the workpiece.



Concrete scabbling using single-head, Vibro-Lo™ Scabbling Hammer



Pneumatic Hand-Held Construction Scabbling Hammers

Model	Description	Model Number	Weight (lbs.)	Dimensions (LxH)	Blows per minute	CFM @ 90 PSI	Noise Level db(A)	Vibration Levels m/s ²
VLSC1 Single Head	Bush Hammer Piston	151.6171	6.5	19" x 6.2"	2800	12	98.5	9.4
	Cruciform Piston	151.6170	6.5	19" x 6.2"	2800	12	98.5	9.4
SC Triple Head	Bush Hammer Pistons	153.6151	10.5	19" x 8.6"	8400	16	98.5	41.6
	Cruciform Pistons	153.6150	10.5	19" x 8.6"	8400	16	98.5	41.6



Heavy-Duty Hand-Held Scabblers



Ideal for more demanding concrete preparation and coating removal applications

CS Unitec's Trelawny™ line of pneumatic heavy-duty hand-held scabblers are ideal for more demanding scabbling applications such as the preparation of concrete cracks for repair and the removal of steel scale deposits.

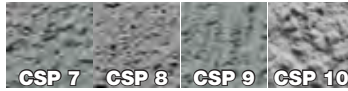

- Single-head, heavy-duty scabblers include integrated Vibro-Lo™ vibration reduction technology
- Single-piece Tungsten Carbide Tipped pistons with Cruciform or Bush heads
- Optional dust shroud for dust and debris collection

Applications include:

- Prepare concrete cracks for repair
- Texturing, roughing, reducing and leveling concrete
- Scabbling concrete to expose aggregate
- Preparing for coatings and waterproofing compounds
- Removing steel scale deposits



Pneumatic Hand-Held Construction Scabbling Hammers

Description	Model No.	Handle Type	Dimensions (LxH)	Weight (lbs.)	CFM @ 90 PSI	Noise Level db(A)	Vibration Levels (m/s ²)
SH1 Single Head – 2900 Blows per minute							
TCT Bush Hammer Piston	151.5250	Long	19" x 6.2"	5	6.5	94	26
TCT Cruciform Piston	151.5200	Long	19" x 6.2"	5	6.5	94	26
TCT Cruciform Piston	199.6190	Short	9.25" x 6"	4.5	6.5	94	26
SH1 w/ Short Handle, Cruciform Piston and Vacuum Shroud, order p/n 139.5190. SH1 w/ Long Handle, Cruciform Piston and Vacuum Shroud, order p/n 139.5192							
VLSH1 Low-Vibration Single Head – 2900 Blows per minute							
TCT Bush Hammer Piston	196.5105	Long	19" x 6.2"	5	9	91	4.5
TCT Cruciform Piston	196.5100	Long	19" x 6.2"	5	9	91	4.5
SH3 Triple Head – 7200 Blows per minute							
TCT Bush Hammer Piston	153.5250	Long	19" x 6.2"	11.5	15.9	98	8.7
TCT Cruciform Piston	153.5200	Long	19" x 6.2"	11.5	15.9	98	8.7
TCT Cruciform Piston	199.6390	Short	9.25" x 6"	7	15.9	98	8.7
SH3 w/ Short Handle, Cruciform Piston and Vacuum Shroud, order p/n 139.5190. SH3 w/ Long Handle, Cruciform Piston and Vacuum Shroud, order p/n 139.5392							

Heavy-Duty Scabblers Accessories

	Part No.	For Model Numbers
Single-Piece Cruciform Piston	612.5320	151.5200, 199.6190, 196.5100, 153.5200 and 199.6390
Single-Piece Bush Piston	612.5325	151.5250, 196.5105 and 153.5250
Whip Check	815.5550	
Lubricators	859.1530	Single-Head Scabblers
	859.1555	Triple-Head Scabblers
Vacuum Shroud*	437.5100	151.5200 and 151.5250
	437.5300	153.5200 and 153.5250

* Not available for low-vibration models



Bush Heads: Ideal for laitance removal, roughening concrete for resurfacing and preparing construction joints. Leaves a heavy pitted profile.



Cruciform Heads: Ideal for removing laitance & coatings, cruciform heads cut through material leaving a flatter finish and profile than bush heads



Concrete scabbling using single-head, Vibro-Lo™ Heavy-Duty Scabblers

Reduce dust and hazardous particles in work area with optional vacuum shroud for Single and Triple Head Heavy-Duty Hand-Held Scabblers (left).

See page 21 for dust extraction systems.

11-Head Floor Scabbler - MHS11



Concrete keying and laitance removal – 11 heads provide 24,000 light blows per minute

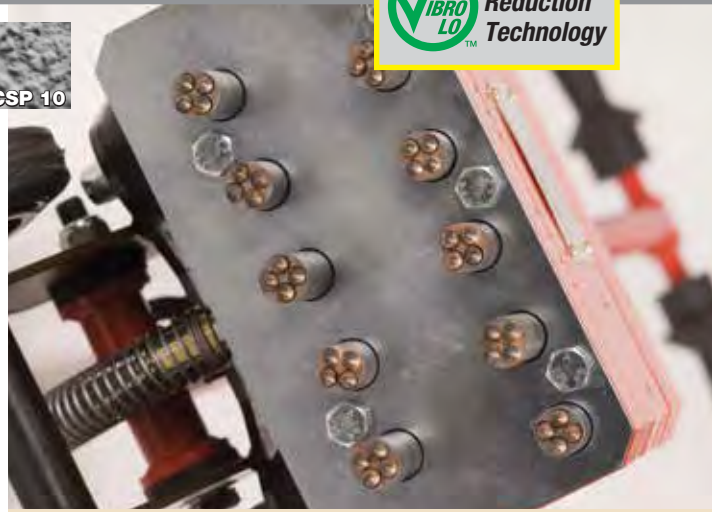

CS Unitec's Trelawny™ MHS11 multi-headed concrete floor scabbler operates with 70% less vibration than standard models. This tool utilizes a 3-point mechanical vibration damping system to offset the hammer vibration created when the head impacts the workpiece.

CS Unitec's Trelawny™ MHS11 Multi-Headed Concrete Floor Scabbler is a portable, compact, low-vibration machine that covers up to 300 sq. ft./hour.

Pneumatic

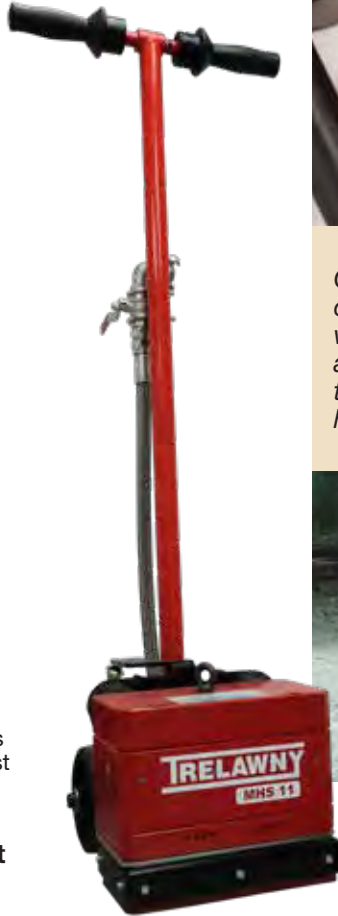

- Integrated Vibro-Lo™ vibration reduction technology
- 24,000 light blows per minute
- Built-in dust shroud and vacuum port for dust and debris collection
- Low air consumption – **only 55 CFM!**

Applications include:

- Concrete keying
- Laitance removal
- Situations requiring gentle, effective scabbling without damaging the substrate below



Integrated 1/2" Dust Port

to collect dust and debris when connected to a dust collection vacuum.

See page 21 for dust extraction systems.

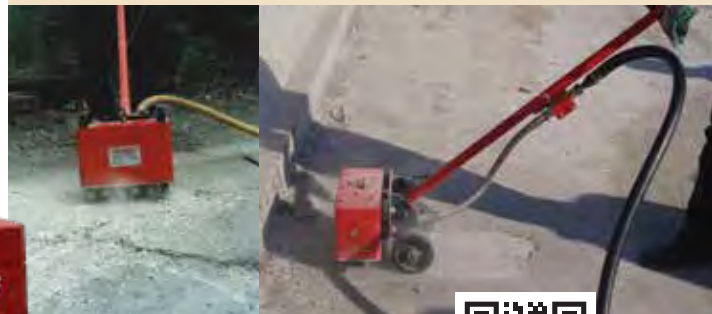

MHS11 Accessories

Part No.

One-Piece Piston TCT Bush Hammer Head	612.0125
Replaceable TCT Bush Hammer Cutter Head	426.5355
Piston for Replaceable Cutter Heads	612.0120
Whip Check	815.5550
Lubricators	859.1580



Bush

Head Applications:

Bush Hammer Heads are ideal for laitance removal; roughing concrete for resurfacing; bridge deck preparation for waterproofing.

MHS11 Low-Vibration Pneumatic Multi-Headed Concrete Floor Scabbler

Model	Description	Model Number	Weight (lbs.)	Dimensions (WxLxH)	Cutting Width	Blows per minute	CFM @ 90 PSI	Noise Level db(A)	Vibration Levels m/s ²
MHS11	With Bush Hammer Heads	159.6050	158	11.25" x 13.5" x 50"	10"	24,200	55	97	4.96



5-Head Floor Scabbler - MHS5

Fast concrete removal and demolition with integrated dust port

CS Unitec's Trelawny™ MHS5 Multi-Headed Concrete Floor Scabbler is the ultimate demolition tool for quick concrete removal – up to 323 sq. ft./hour.

- 6500 BPM for fast removal and demolition
- Integrated dust shroud for dust and debris collection
- Vibration dampers for improved operator comfort
- Large wheels for rough terrain
- Hand lever throttle

Applications include:

- Leveling high spots
- Texturing and roughening for sealant and overlay preparation

**Efficient operation
ONLY 80 CFM!**

**50% lower air consumption
than the competition!**

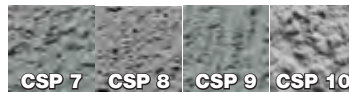

Removal of hazardous or contaminated materials via built-in 2" dust port.

See page 21 for dust extraction systems.



MHS5 Accessories

	Part No.
Cruciform Scabbler Head	441.5360
5-Point Bush Hammer Head	441.5359
9-Point Bush Hammer Head	441.5369
Whip Check	815.5550
Lubricators	859.1580
Dust Shroud	Included



Head Applications:

Cruciform Scabbler Heads are ideal for leveling floors, reducing concrete and removing floor paints and coatings.

5-Point Bush Hammer Heads are more aggressive, ideal for removing laitance from large floor areas, roughing concrete prior to resurfacing and preparing bridge decks for waterproofing.

9-Point Bush Hammer Heads leave a finer profile and are ideal for removing laitance from large floor areas, roughing concrete prior to resurfacing and preparing bridge decks for waterproofing.

MHS5 Pneumatic Multi-Headed Concrete Floor Scabbler

Model	Description	Model Number	Weight (lbs.)	Dimensions (WxLxH)	Cutting Width	Blows per minute	CFM @ 90 PSI	Noise Level db(A)	Vibration Levels m/s ²
MHS5	5-Point Bush Head	159.5050	251	28" x 43" x 38"	11"	6500	80	94.7	16.5
	9-Point Bush Head	159.5075	251	28" x 43" x 38"	11"	6500	80	94.7	16.5

Pole Scabblers/Tampers



With pole lengths of 50" and 55", CS Unitec's Trelawny™ pole scabblers allow for the fast removal of material with a wide range of interchangeable scabbling heads, and the backfilling of small areas with tamper feet.

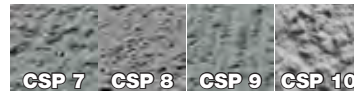

The low-vibration Model VL LRS55 operates with 8x less vibration than standard models for greater productivity and improved operator comfort.

CS Unitec offers interchangeable scabbling heads and tamper feet to suit most applications.



- Long handles for extended reach into hard-to-access areas
- Production rates of up to 130 sq. ft./hour
- Interchangeable scabbling heads and tamper feet
- Integrated Vibro-Lo™ low vibration technology
- Angled air inlet to direct hose away from operator
- Hand guard to protect user



VL LRS55



LPS55



Applications include:

- Heavy scabbling of hard-to-access areas
- Scabbling of corners, edges and joints
- Aggressive keying without damaging substrate

Pole Scabbling/Tamper Accessories

5-Point Bush Scabbling Head (includes fit pin)	441.5359
9-Point Bush Scabbling Head (includes fit pin)	441.5369
Cruciform Scabbling Head (includes fit pin)	441.5360
Round Compactor Foot (5" diameter)	450.5017
Square Compactor Foot (4" x 4")	450.5011
Compactor Foot (6" x 5")	450.5013
Compactor Foot (4" x 8")	450.5016
Whip Check	815.5550

Low-Vibration Pole Scabbling/Tamper

Model	Description	Model Number	Weight (lbs.)	Length	Cutter Life	Blows per min.	CFM @ 90 PSI	Vibration Levels Aeq m/s ²
VL LRS55 	5-Point Scabbling Head	150.5320	47.5	50"	12,000 sq. ft.	1300	25	4.2
	9-Point Scabbling Head	150.5321	47.5	50"	12,000 sq. ft.	1300	25	4.2
	5" Round Compactor Head	150.5331	47.5	50"	12,000 sq. ft.	1300	25	3.5
	4"x4" Compactor Foot	150.5330	47.5	50"	12,000 sq. ft.	1300	25	3.5
	6"x5" Compactor Foot	150.5335	47.5	50"	12,000 sq. ft.	1300	25	3.5

Standard Pole Scabbling/Tamper

Model	Description	Model Number	Weight (lbs.)	Length	Cutter Life	Blows per min.	CFM @ 90 PSI	Vibration Levels Aeq m/s ²
LPS55	5-Point Scabbling Head	150.5001	29.5	55"	12,000 sq. ft.	1100	24.6	35.0
	9-Point Scabbling Head	150.5002	29.5	55"	12,000 sq. ft.	1100	24.6	35.0
	5" Round Compactor Head	150.5031	28.6	55"	12,000 sq. ft.	1100	24.6	44.5
	4"x4" Compactor Foot	150.5030	28.6	55"	12,000 sq. ft.	1100	24.6	43.0
	6"x5" Compactor Foot	150.5021	29.75	55"	12,000 sq. ft.	1100	24.6	43.6

Hand-Held Scarifiers - Pneumatic and Electric

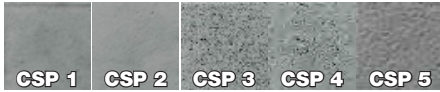

Peening Preparation Tool (PPT) – ideal alternative to small-area shot blasting

CS Unitec's Genuine Trelawny™ Rotopeen™ hand-held scarifiers are the ideal alternative to small-area shot blasting for cleaning and preparing concrete and steel surfaces. They utilize 3M's brand of Rotopeen™ 'C' flaps to offer a captive shot method of surface preparation.

- Integrated dust shroud for dust and debris collection, as well as cleaner, safer removal of lead-based paints and contaminated particles

Applications include:

- Aggressive removal of alkyds, adhesives, lead-based paints, mastics, coatings, corrosion & more
- Cleaning & preparing steel and concrete surfaces



Air Models
194.0405 and
194.C405,
4" cutting width



Optional Accessory

Above: Optional top handle attachment kit to replace rubber grip on 2" and 4" models. (P/N 312.Q450)



3M™ ROTOPEEN FLAP FINISH



Above: Ergonomic rubber hand grip standard on all new 2" and 4" models. Provides grip for easier pushing along material.

See page 21 for dust extraction systems.

Hand-Held Scarifier Accessories	Star Cutter	Beam Cutter	3M™ Rotopeen™ 'C' Flap	Star Cutter	Beam Cutter	Rotopeen™ 'C' Flap
	P/N 312.S200 <i>Aggressive removal of thick coatings</i>	P/N 312.R200 <i>Removal of hard coatings, less aggressive than star cutter</i>	P/N 312.MRPC <i>Removal of paint and rust to bare metal finish</i>			
	HEAVY SCALING ←————→ SURFACE PROFILING			2"	80	2"
				4"	160	4"
Nuclear	—	—	Radioactive waste removal/capture			
Ships decks	Non-slip coatings	—	General paint removal			
Construction	Plaster removal	Ceiling / wall paint removal	Ceiling / wall paint removal	2"	56	2"
Factory Floors	—	Floor marking removal	Floor marking removal	4"	112	4"
Swimming Pools	Adhesive removal	Adhesive removal	—			
Bridge Maintenance	Sealant removal	—	Paint / sealant removal	2"	6	2"
Pipeline Maintenance	—	—	Protective coating removal	4"	12	4"

Pneumatic Hand-Held Scarifiers

Model Number	CFM @ 90 PSI	Speed (RPM)	Cutting Width	Cutting Media	Weight (lbs.)	Vibration Levels m/s ²
194.0205	30	2700	2"	'C' Flaps	7.5	3.5
194.C205	30	2700	2"	Star Cutters	11.5	6.0
194.0405	30	2700	4"	'C' Flaps	9	3.1
194.C405	30	2700	4"	Star Cutters	13.25	4.6

These models are compatible with Star Cutters, Beam Cutters and Rotopeen™ 'C' Flaps



Electric Hand-Held Scarifiers

Model Number	Motor Power	Speed (RPM)	Cutting Width	Cutting Media	Weight (lbs.)	Vibration Levels m/s ²
195.1217	110V	2000	2"	'C' Flaps	11	3.6
195.1220	220V	2000	2"	'C' Flaps	11	3.6



Electric Model 195.1220 2" cutting width with Rotopeen™ 'C' flaps. 4" width also available.



Floor Scarifiers - Gas • Electric • Pneumatic

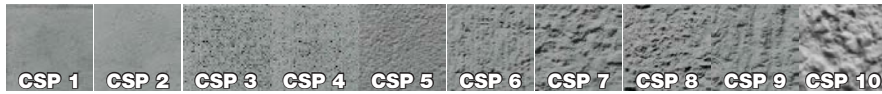

Remove coatings, paint adhesives and more, as well as level and profile concrete

CS Unitec's Trelawny™ Floor Scarifiers tackle the most demanding surface preparation and material removal applications. Ideal for removing coatings and corrosion from concrete and steel surfaces to prepare for re-coating. Produce an ideal keyed or grooved profile on concrete for waterproofing and non-slip surface applications.

- Depth control maximizes performance and extends cutter life
- Integrated vacuum connection and hold-to-run handle
- Fully adjustable handlebar for operator comfort
- Electric, pneumatic or gas power

Applications include:

- Removal of coatings, paint, adhesives, rust, scale and more from concrete and metal
- Keyed or grooved profiles
- Roughing concrete



TFP 200 Cutters

	Individual Cutter	Cutters/Spacers Required Per Drum	Drum Assembly
Wire Brushes	N/A	N/A	320.9620
Beam Cutters*	320.5120	226 Pieces	320.1020SB
Star Cutters*	320.3658	208 Pieces	320.1020SS
TCT Cutters Spacers*	320.5500 320.4140	80 Pieces 88 Pieces	320.1020ST
Milling Cutters (22mm)*	320.5600 320.4140	24 Pieces 72 Pieces	320.1020SM
TCT Cutters (for grooving) Spacers*	320.5500 320.4140	24 Pieces 232 Pieces	320.002G

* Beam, Star, Milling and TCT Cutters are compatible with other manufacturers' models.

Cutter Applications:

Wire Brushes: ideal for finish cleaning and polishing on steel; can be used for light concrete deposit.

Beam Cutters: ideal for light paint/corrosion removal, with minimal damage to substrate.

Star Cutters: ideal for removal of mastics and rubberized coatings.

Tungsten Carbide-Tipped (TCT) Cutters: ideal for aggressive applications such as roughing concrete and heavy corrosion removal, as well as grooving roadways for non-slip surface.

Milling Cutters: ideal for removal of plastic road markings without penetrating the surface.

TFP 200 Floor Scarifiers

Every TFP 200 machine includes mounted drum and cutters

Model Number	Motor Specifications	Max Cutting Depth per Pass	Cutting Width	Dimensions (WxLxH)	Weight (lbs.)
TFP 200 Electric					
320.2342T	120V, 50/60 Hz, 1 Phase, 1.5 HP	1/8"	8"	14" x 35" x 35"	149
320.2404T	230V, 50/60 Hz, 1 Phase, 3 HP	1/8"	8"	14" x 35" x 35"	149
TFP 200 Pneumatic					
320.2012T	165CFM @ 90 PSI, 3.5 HP	1/8"	8"	14" x 35" x 35"	99
TFP 200 Gas					
320.2000T	Honda GX160 Gas, 5.5 HP	1/8"	8"	14" x 35" x 35"	130

Contact us for more information on TFP200 Electric, 460V, model no. 320.2406T



Floor Scarifiers - Electric • Gas



TFP 260 floor scarifier with 10" cutting width for medium to large jobs

Remove coatings and corrosion from concrete and steel surfaces to prepare for re-coating. Level and remove hard materials. Remove painted lines.

- Depth control maximizes performance and extends cutter life
- Integrated vacuum connection for dust-free operation
- Quick-lift drum lever for operator control
- Gas or electric power



Ideal for grooving concrete surfaces



TFP 260 Cutters

	Individual Cutter	Cutters/Spacers Required Per Drum	Drum Assembly
Beam Cutters	326.5120	332 Pieces	326.1016DB
Star Cutters	326.3658	342 Pieces	326.1016DS
TCT Cutters Spacers	320.7009 320.4160	123 Pieces 129 Pieces	326.1016ST
Milling Cutters (16mm)	320.5680	60 Pieces	326.1016DM
TCT Cutters (for grooving) Spacers	320.7009 320.4160	36 Pieces 224 Pieces	326.1016GT



TFP 260 Floor Scarifiers

Every TFP 260 machine includes a mounted drum and cutters

Model Number	Motor Specifications	Max Cutting Depth per Pass	Cutting Width	Dimensions (WxLxH)	Weight (lbs.)
TFP 260 Gas					
326.2000T	Honda GX240 Gas, 8 HP	1/4"	10"	17" x 44" x 45"	408
TFP 260 Electric					
326.2006T	415V, 50/60 Hz, 3-Phase, 7.5 HP	1/4"	10"	17" x 44" x 45"	408

Heavy-Duty Needle Scalers

Heavy-Duty Needle Scalers

Ideal for cleaning and stress-relieving weld seams and joints; texturing concrete; removing coatings, corrosion and other accumulated materials.

Power & Productivity

- Oversized piston produces more power than the competition – while consuming 2/3 less air!
- Heavy-duty hardened anvil
- Chisel-tipped needles

Low Maintenance & Less Downtime

- Air-powered – fewer moving parts
- Converts to chisel scaler in seconds
- Piston valve

Versatile

- One tool for different applications
- Lightweight – easy to handle

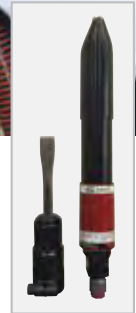

2B Combination Kit
See next page for more information.

Grip	Description	Model Number	Needle Qty./Dia.	Weight (lbs.)	Blows per minute	CFM @ 90 PSI	Noise Level dB(A)	Vibration Levels m/s ²	Service Kit Part No.
Inline	1B Needle Scaler	111.1099	12 / 3mm	3.5	3800	3.0	110.4	8.5	446.1010
	2B Needle Scaler	121.2099	19 / 3mm	5.75	3000	5.5	113.3	9.3	446.1020
Pistol	2BPG Needle Scaler	123.2199	19 / 3mm	5.75	3000	5.5	113.3	12.6	446.1025
	3BPG Needle Scaler	133.3199	28 / 3mm	8.25	2200	8.0	114.5	18.9	446.1035

Service kits available. Visit our website for more information.



Dust Collection Shrouds and Cuffs for Standard Needle Scalers

Model Series	Dust Shroud	V Cuff	Edge Cuff	Flat Cuff
2B & 2BPG	P/N 418.2200	P/N 731.2101	P/N 731.2102	P/N 731.2103
3BPG	P/N 418.3040	P/N 731.3101	P/N 731.3102	P/N 731.3103



Needle options – see page 18 for the following types of needles:

Flat	Chisel	Pointed	Copper Beryllium	Stainless Steel
light treatment and polishing effect	light surface marking	very hard scale	use in potentially explosive areas ⚠	use in areas where contamination from carbon steel is a problem such as stainless steel fabrication, areas of high humidity and corrosion

TVS™ Needle Scalers with Integrated Vacuum Shroud



CS Unitec's Trelawny™ TVS™ Needle Scalers with Integrated Vacuum Shroud enable dust-free working in hazardous applications when used with a dust extraction vacuum (see page 21 for dust collection systems). TVS Needle Scalers come standard with corner cuff, edge cuff and flat cuff.



Grip	Description	Model Number	Weight (lbs.)	Blows per minute	CFM @ 90 PSI	Noise Level dB(A)	Vibration Levels m/s ²	Service Kit Part No.
Inline	2B Needle Scaler	139.2007	6.4	3000	5.5	98.6	17.4	446.1020
Pistol	2BPG Needle Scaler	139.2107	6.6	3000	5.5	98.6	22.4	446.1025
	3BPG Needle Scaler	139.3107	9.9	2200	8.0	105.1	19.9	446.1035

Service kits available. Visit our website for more information.

Heavy-Duty Chisel Scalers

Heavy-Duty Chisel Scalers

Ideal for splitting, chipping, pointing, brick raking and removing accumulated materials and corrosion.

- Inline, pistol and semi-pistol grip
- Ball bearing chisel retainer



Grip	Description	Model Number	Weight (lbs.)	Blows per minute	CFM @ 90 PSI	Noise Level dB(A)	Vibration Levels m/s ²	Service Kit Part No
Inline	1B Chisel Scaler	114.1200	3.3	3800	3.0	98.9	8.2	446.1012
	2B Chisel Scaler	124.2200	4.4	3000	5.5	98.6	17.4	446.1022
Pistol	2BPG Chisel Scaler	125.2300	4.5	3000	5.5	98.6	22.4	446.1027
	3BPG Chisel Scaler	135.3300	6.2	2200	8.0	105.1	25.6	446.1037
	3BPG Chisel Scaler*	135.3395	6.2	2200	8.0	105.1	25.6	446.1037

* 3BPG Chisel Scaler 135.3395 has 5/8" hexagonal chisel holder and is compatible with chisels shown on page 19. All others Chisel Scalers shown above have 1/2" square connection. Service kits available. Visit our website for more information.



2B & 2BPG Combination Kits

Inline Kit includes 2B Needle Scaler, 19 (3mm) needles, 3/4" width chisel and allen wrench. P/N 199.3120 (shown)

Pistol Grip Kit includes 2BPG Needle Scaler, 19 (3mm) needles, 3/4" width chisel and allen wrench. P/N 199.3121



Chisels for Standard Chisel Scalers

1/2" Square Connection

Chisel Part No.	Shank	Length	Width	Application
704.1110	Square	7"	2"	Spark-resistant Aluminum Bronze  for use in hazardous areas
704.2105	Square Cranked End	7"	1-3/8"	Weld flux and thick coating removal
704.1101	Square	7"	3/4"	Weld splatter removal
704.1103	Square	7"	2-1/2"	Wide flat chisel for the removal of rust or peeling paint
704.1107	Square	10"	3/4"	Flat chisel for weld splatter and sand cast cleaning
704.1106	Square	8"	1/4"	Mortar removal for repointing brick work
704.1112	Square	7"	Moil Point	Concrete chipping

CS Unitec offers a full line of non-sparking, non-magnetic chisels and safety hand tools for hazardous areas and Ex zones. Contact us for details.

Standard Needle Scalers and Chisel Scalers convert in seconds with optional head or when purchased as a Kit. Contact us for more information.

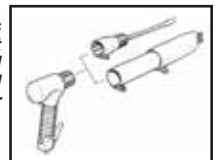

Low-Vibration Needle/Chisel Scalars



High power with low vibration – 8x less than standard models

CS Unitec's Trelawny™ line of Low-Vibration needle/chisel scalars offer high performance and low vibration for greater productivity and improved operator comfort. Ergonomically designed with low maintenance and quick change tooling option.

- Integrated Vibro-Lo™ vibration reduction technology
- Low air consumption
- Optional dust shroud for dust and debris collection
- Tool-free needle changeover
- Converts to chisel scaler in seconds



Dust Collection Shroud

CS Unitec's Trelawny™ Vibro-Lo™ line of Needle/Chisel Scalars operate with 8x less vibration than standard models. These tools utilize vibration damping components to offset the hammer vibration created when the needles/chisels impact the workpiece.



VL223



VL203

VL303



Needle Scalars and Chisel Scalars convert in seconds with optional head or when purchased as a Kit. See page 16 for Kit information.

ATEX-Certified Needle Scalars available for hazardous environments and Ex Zones. See page 17 for details.

Applications include:

- Cleaning and stress-relieving weld seams and joints
- Removing coatings, corrosion and other accumulated materials
- Texturing concrete
- Splitting, chipping, pointing and brick raking



Heavy-Duty Low-Vibration Needle Scalers



Heavy-Duty Vibro-Lo™ Needle Scalers

- Inline or pistol grip
- Remove coatings, corrosion and other accumulated materials
- Ideal for stress-relieving weld seams and joints



Needle Scalers and Chisel Scalers convert in seconds with optional head or when purchased as a Kit. See page 16 for Kit information.

Grip	Description	Model Number	Needle Qty./Dia.	Weight (lbs.)	Blows per minute	CFM @ 90 PSI	Noise Level dB(A)	Vibration Levels m/s ²	Service Kit Part No.
Inline	VL223 Needle Scaler	199.2103	19 / 3mm	5.25	2400	4.0	90.7	2.56	446.2003
	VL223 Needle Scaler w/ dust shroud	199.2313	19 / 3mm	5.25	2400	4.0	90.7	2.56	446.2003
Pistol	VL203 Needle Scaler	199.2003	19 / 3mm	6	2400	4.0	90.7	2.75	446.2003
	VL203 Needle Scaler w/ Dust Shroud	199.2303	19 / 3mm	6	2400	4.0	90.7	2.75	446.2003
	VL303 Needle Scaler	199.3003	28 / 3mm	7.75	3000	5.5	109.5	2.30	446.3003
	VL303 Needle Scaler w/ Dust Shroud	199.3005	28 / 3mm	7.75	3000	5.5	109.5	2.30	446.3003

Service kits available. Visit our website for more information.

Needle options – see page 18 for the following types of needles:

Flat	Chisel	Pointed	Copper Beryllium	Stainless Steel
light treatment and polishing effect	light surface marking	very hard scale	use in potentially explosive areas	use in areas where contamination from carbon steel is a problem such as stainless steel fabrication, areas of high humidity and corrosion

Dust Collection Shroud for Vibro-Lo™ Needle Scalers



See page 21 for dust extraction systems.



Drop Protection Kit

CS Unitec offers a drop protection kit for our Vibro-Lo™ Needle/Chisel Scalers. Protect your workers from risk of serious injury from falling objects. Also protect your investment when working at heights or in applications where dropping/ losing the tool is likely, including: offshore platforms and rigs, bridges/scaffolding, vessels and ships.



For VL223 and VL203
Order P/N 720.2003*

For VL303
Order P/N 720.3003*

* Safety clip and line not supplied



Dust Collection Shrouds and Cuffs for Vibro-Lo™ Needle Scalers

Model Series	Dust Shroud	V Cuff	Edge Cuff	Flat Cuff
VL223 & VL203	P/N 418.2003	P/N 731.2101	P/N 731.2102	P/N 731.2103
VL303	P/N 418.3003	P/N 731.3101	P/N 731.3102	P/N 731.3103

Heavy-Duty Low-Vibration Chisel Scalers

Equipped with **Vibro-Lo™** low vibration technology for 8x less vibration than standard models



Grip	Description	Model Number	Weight (lbs.)	Blows per minute	CFM @ 90 PSI	Noise Level dB(A)	Vibration Levels m/s ²	Service Kit Part No.
Inline	VL223 Chisel Scaler	199.2213	6.5	2400	4	76.3	3.69	446.2203
Pistol	VL203 Chisel Scaler	199.2203	7	2400	4	76.3	3.33	446.2203
	VL303 Chisel Scaler	199.3203	9.5	3000	5.5	78.2	3.7	446.3303



Service kits available. Visit our website for more information.

Chisels for Vibro-Lo™ Chisel Scalers

Chisel Part Number **Shank** **Length** **Width** **Application**

	704.3110	Square	7"	2"	Spark resistant Aluminum Bronze for use in hazardous areas
	704.3205	Square Cranked End	7"	1-3/8"	Weld flux and thick coating removal
	704.3101	Square	7"	3/4"	Weld splatter removal
	704.3103	Square	7"	2-1/2"	Wide flat chisel for the removal of rust or peeling paint
	704.3107	Square	10"	3/4"	Flat chisel for weld splatter and sand cast cleaning



CS Unitec offers a full line of non-sparking, non-magnetic chisels and safety hand tools for hazardous areas and Ex zones. Contact us for details.



Vibro-Lo™ Needle/ Chisel Scaler Kits

CS Unitec offers Vibro-Lo™ Needle/Chisel Scaler Kits, each supplied with the Needle Scaler, 3mm needles, a chisel holder, anvil and a 3/4" blade chisel.

- VL223 Kit** – Order P/N 199.2113
- VL203 Kit** – Order P/N 199.2105
- VL303 Kit** – Order P/N 199.3103



VL303 Kit – Plastic carrying case included.

VL223 Kit and VL203 Kit do not include a plastic carrying case.

ATEX-Certified Needle and Chisel Scalars



Specially-designed for use in hazardous environments – equipped with Vibro-Lo™ low vibration technology

These specially engineered Trelawny VL203Ex, VL223Ex and VL303Ex needle and chisel scalars are:

- Fully certified to the classification: Ex II 2 G Ex h IIC T4 Gb (GAS) and Ex II 2 D Ex h IIC T135 °C Db (DUST) under the European Directive 94/9/EC
- Ideal for use in oil, gas & petrochemical industries such as refineries, offshore platforms, LPG terminals and all chemical processing environments.

ATEX Certified

For use in hazardous environments and ATEX and Ex Zones



Grip	Description	Model Number	Needle/Chisel Supplied	Tool Weight (lbs.)	Blows per minute	CFM @ 90 PSI	Noise Level dB(A)	Vibration Levels m/s ²	Service Kit Part No.
Inline 	VL223Ex Needle Scaler	196.2107	19 qty. / 3mm dia.	5.25	2400	4.0	90.7	2.56	446.2003X
	VL223Ex Chisel Scaler	196.2117	2" (50mm) AlBr	6.5	2400	4.0	90.7	3.69	446.2203X
	VL223Ex Needle Scaler Kit	139.2423	19 qty. / 3mm dia.	5.25	2400	4.0	90.7	2.56	446.2003X
Pistol 	VL203Ex Needle Scaler	196.2207	19 qty. / 3mm dia.	6	2400	4.0	90.7	2.75	446.2003X
	VL203Ex Chisel Scaler	196.2217	2" (50mm) AlBr	7	2400	4.0	90.7	3.33	446.2203X
	VL203Ex Needle Scaler Kit	139.2403	19 qty. / 3mm dia.	6	2400	4.0	90.7	2.75	446.2003X
	VL303Ex Needle Scaler	196.3007	28 qty. / 3mm dia.	7.75	3000	5.0	109.5	2.3	446.3003X
	VL303Ex Chisel Scaler	196.3017	2" (50mm) AlBr	9.4	3000	5.0	109.5	3.7	446.3303X
	VL303Ex Needle Scaler Kit	139.2433	28 qty. / 3mm dia.	7.75	3000	5.0	109.5	2.3	446.3003X

Aluminum bronze chisel supplied with chisel scaler, p/n 704.3110. Copper beryllium chisel-tip needles supplied with needle scalars, box of 19 (p/n 403.1319), box of 28 (p/n 403.1328).

ATEX Kit Features



Copper Beryllium needles – high strength with non-sparking and non-magnetic properties



Dust shroud to protect user from hazardous dust and debris (standard in kits only)



Fall arrestor eliminates the risk of dropping the tool causing injury or equipment damage (standard in kits only)



Vibro-Lo™ technology operates with 8x less vibration than standard models.



Needle Scaler Kits include ATEX-Certified needle scaler, extra set of Copper Beryllium needles, dust shroud, corner cuff, edge cuff, flat cuff and fall arrestor.



Optional Accessory
Anti-static lanyard available for use with the fall arrestor (P/N 415.3003)



Non-Sparking, Non-Magnetic Safety Hand Tools

CS Unitec offers a complete line of high-quality safety hand tools for use in Ex Zones, ATEX Zones and hazardous environments where hazardous, flammable or combustible vapors, liquids, dusts or residues may be present. **Contact us for more information!**

Needles

CS Unitec's Trelawny™ needles last 10x longer than standard needles. Save time and money with fewer needle changes and less downtime.



All of CS Unitec's Needle Scalers are delivered from stock complete with 7" long x 3mm diameter chisel tipped high performance needles. Other needle holders are available as accessories for use with 2mm and 4mm diameter needles. We also offer spark resistant needles for use in potentially hazardous areas and Ex zones, as well as stainless steel needles for use in humid areas – such as applications in the food processing industry – where corrosion is a concern.

Standard pack set is one carton of 6 sets. Some models are packed as an individual set in a box. Boxes of 100 qty. needles in a durable, reusable plastic container are available, as well as larger quantities.

Chisel Tip

These needles will clean the same materials as a pointed tip, but will leave light surface marking



Size	Description	Part #
3mm	1 set of 19 needles	403.2119
3mm	1 set of 28 needles	403.2128
3mm	6x sets of 12 needles	413.2112
3mm	6x sets of 19 needles	413.2119
3mm	6x sets of 28 needles	413.2128
3mm	Box of 100 needles	453.2110
3mm	Box of 1000 needles	443.2107

Flat Tip

Flat-tipped needles will reduce marking on metal surfaces and can give a polishing effect. For use on thin gauge metals and any surface where a light treatment is required.



2mm needles used on a welded joint produce a similar effect to shot peening, reducing stress in the weld.

Size	Description	Part #
2mm	6x sets of 29 needles	412.1129
2mm	6x sets of 51 needles	412.1151
2mm	6x sets of 65 needles	412.1165
2mm	Box of 100 needles	452.1110
2mm	Box of 2000 needles	442.1107
3mm	1 set of 19 needles	403.1119
3mm	1 set of 28 needles	403.1128
3mm	6x sets of 19 needles	413.1119
3mm	6x sets of 28 needles	413.1128
3mm	Box of 100 needles	453.1110
3mm	Box of 1000 needles (180mm long)	443.1107
4mm	6x sets of 19 needles	414.1119
4mm	6x sets of 35 needles	414.1135
4mm	Box of 50 needles	454.1105
4mm	Box of 500 needles	444.1107
3mm	Box of 1000 needles 5" long (127mm)	443.1105
3mm	19 needles, 5" long (127mm)	443.1115

Pointed Tip

Sharpened to a conical point, these are the most effective in breaking through very hard scale on materials where some surface indentation is permissible – or where a roughening or keying of the surface is actually desirable.



Size	Description	Part #
3mm	6x sets of 19 needles	413.3119
3mm	6x sets of 28 needles	413.3128
3mm	6x sets of 49 needles	413.3149
3mm	Box of 100 needles	453.3110
3mm	Box of 1000 needles	443.3107
4mm	6x sets of 19 needles	414.3119
4mm	6x sets of 35 needles	414.3135
4mm	Box of 50 needles	454.3105
4mm	Box of 500 needles	444.3107



See page 21 for dust extraction systems.

Conversions:

2mm = 0.08"
3mm = 0.12"
4mm = 0.16"
180mm = 7"

Spark-Resistant Copper Beryllium

Available in 3mm flat tip only; for use in potentially hazardous areas.

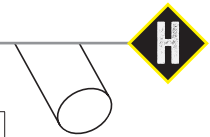

Size	Description	Part #
3mm	1 set of 12 needles	403.1312
3mm	1 set of 19 needles	403.1319
3mm	1 set of 28 needles	403.1328
3mm	Box of 49 needles	403.1349
3mm	Box of 100 needles	453.1310
3mm	Box of 500 needles	443.1307

Stainless Steel

Available in 3mm flat tip only, to be used in stainless steel fabrication applications such as food production equipment or in areas of high humidity where the corrosive effect on needles would be prohibitive. Used on decorative concrete surfaces where contamination of the surface from carbon steel needles is undesirable.

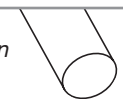

Size	Description	Part #
3mm	Box of 100 needles	453.1207
3mm	Box of 500 needles	443.1207

Long-Reach Chisels/Scrapers/Scalers



Chip, scrape and descale with one versatile tool

CS Unitec's Trelawny™ Long-Reach Scrapers feature one tool with multiple applications.

- Available in 2', 4', 5' and 6' lengths
- 3 tools in 1 – chipper, scraper and descaler
- Quick-change chisel release
- Low air consumption
- Standard and "LITE" models



3 tools in 1:

Chipping
A



Scraping
B



Descaling
C

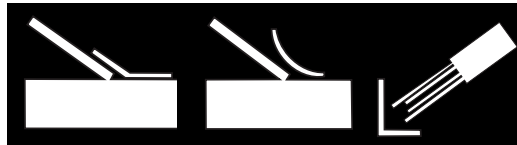

Accessories sold separately.

Applications include removal of:

- Ice
- Residue
- Adhesive
- Asbestos
- Linoleum
- Carpeting
- Plaster
- Mortar
- Floor tiles
- Metal slag
- Rubber coatings
- Roofing materials
- Chemical spillages
- Bituminous products

Long-Reach Chisels/Scrapers

Model	Description	Model No.	Weight (lbs.)	Blows per minute	CFM @ 90 PSI	Noise Level dB(A)
Standard Needle Scalers	2ft. Needle	137.3200	10.5	2200	4.5	103
	4ft. Needle	137.3400	12.5	2200	4.5	104
	5ft. Needle	137.3500	13.5	2200	4.5	103
	6ft. Needle	137.3600	15	2200	4.5	104
LITE Needle Scalers	4ft. Needle	136.3498	8	2200	4.5	105
	5ft. Needle	136.3598	9	2200	4.5	105
	6ft. Needle	136.3698	10	2200	4.5	105
Standard Chisel Scalers	2ft. Chisel	136.3299	8	2200	4.5	82
	4ft. Chisel	136.3499	11	2200	4.5	81
	5ft. Chisel	136.3599	11	2200	4.5	83
	6ft. Chisel	136.3699	14	2200	4.5	84
LITE Chisel Scalers	4ft. Chisel	136.3497	6.75	2200	4.5	86
	5ft. Chisel	136.3597	7.5	2200	4.5	81
	6ft. Chisel	136.3697	8.5	2200	4.5	84

A: Chisel Accessories - 5/8" hex

Part No.	Length	Blade Width	Applications
705.1100	9"	2"	Spark-resistant aluminum bronze for use in hazardous areas
705.1101	9"	1"	Flat chisel for sand cast chipping
705.1102	8"	4"	Asphalt cutter/paint removal/general chipping applications
705.1106	9"	2"	Removal of linoleum from floor base
705.1112	8"	4"	Spark-resistant aluminum bronze for use in hazardous areas
705.2102	8"	4"	Floor tile removal
708.1101	1"	1-1/8" comb insert	Brick cleaning and reclamation (use with 8" long comb holder 708.1100)



C: Needle Scaler Accessories

All long-reach scrapers are available as needle scalers by changing the scraper/chisel with the needle attachment P/N 415.3532. See page 18 for needles.

B: Scraper Accessories

(Assembly includes holder and 1 blade)

Assembly Part No.	Blade Pack	Blade Width	Applications
Flat			
431.3504	439.3504 (5 Blades)	4"	Adhesive and paint build up removal
431.3508	439.3508 (5 Blades)	8"	Paint and coating spillage removal
431.3512	439.3512 (4 Blades)	12"	Carpet and tile removal
Beveled			
431.3904	439.3524 (5 Blades)	4"	Stubborn adhesive removal
431.3908	439.3528 (5 Blades)	8"	Carpet and tile removal
431.3912	439.3522 (4 Blades)	12"	Adhesive removal

Dust Collection Vacuums with HEPA Filtration

CS Unitec's dust extraction vacuums offer strong 157 CFM air flow and an electromagnetic pulse filter cleaning system to maximize vacuum power and dust collection.

- 99.999% HEPA filtration efficiency of particles down to 0.3 microns; automatic filter cleaning
- "Power Take Off" outlet activates the vacuum ON/OFF from the power tool switch
- Non-HEPA models available, 99.930% filtration efficiency
- CS 1225 and 1445 vacuums include 15' of 1-1/2" hose and a 26' power cord
- Kit available to connect two power tools (P/N 198804)



Model CS 1445 H automatically "pulse" cleans filters without interrupting operation!

Optional Filter Bags

Fleece filter bags for CS 1225 and CS 1445
P/N 435305 (5-pack)

Plastic filter bags for CS 1225 and CS 1445
P/N 421742 (5-pack)

Cleaning Kit for CS 1225 and CS 1445

P/N 063201 - Includes floor cleaning tool, crevice tool, 2 tubes and handle.



"Power Take Off" outlet

CS 1225 HF

HEPA Vac Specifications

	CS 1225 HF	CS 1445 H
Power	11 Amp	11 Amp
Air flow	157 CFM	157 CFM
Static Water Lift	98"	98"
Tank capacity	6.6 gal.	9 gal.
Weight	24.3 lbs.	35 lbs.
Filter P/N (2pk.)	428956	428956

Standard Vacuum Specifications

	CS 1225	CS 1445
Power	11 Amp	11 Amp
Air flow	157 CFM	157 CFM
Static Water Lift	98"	98"
Tank capacity	6.6 gal.	9 gal.
Weight	24.3 lbs.	35 lbs.
Filter P/N (2pk.)	416069	416069



Activate vacuum on/off from power tool controls

Collect concrete, stone drywall and wood dust directly from tools



Wood Dust Collection HEPA Vacuum

CS 1445 H vacuum, HEPA filters, 15' anti-static hose, tool adapter and 26' power cord (P/N CS 1445 H WOOD)



Air-Powered Dust Collection Vacuum – KAV 30 AIR

Collection of dry dust/debris and non-flammable liquids
ATEX classified; antistatic vacuum and air-supply hose



- Antistatic vacuum and air supply hose
- ATEX classified Ex II 2 GcT6 for use in Gas Zone 2 and Dust Zone 22
- Robust stainless steel construction
- Floor tool kit for general cleaning work
- 2x filtration with optional 14" Permaflow filter
- Optional HEPA filter – for collection of hazardous dust
- Disposable paper filter bag or sealable paper bags for sealed disposal of hazardous waste/dust

KAV 30 AIR Vacuum Specifications

	Dry Model 303.10KAV30/D	Wet/Dry Model 303.10KAV30/WD
Air Consumption @ 90 PSI	35	35
Air flow	70 CFM	70 CFM
Tank capacity	6.8 gal.	6.8 gal.
Weight	32 lbs.	32 lbs.
Paper Filter P/N (10pk.)	303.1030	303.1030
HEPA Filter P/N	303.1060	303.1060
Paper Bags P/N (10pk.)	303.1005	303.1005

We make no claim that use of a vacuum will eliminate contaminants. Wear an approved respirator mask and follow all appropriate OSHA safety regulations for proper ventilation, dust handling, eye protection, etc. when using a dust extraction grinder and vacuum.

Caution: User must follow all appropriate safety regulations when choosing a tool for their particular working environment.



Low-Vibration Hand-Held Grinders

CS Unitec's concrete grinders are powerful and efficient. The unique parallel grip design and vibration reduction technology provide more comfortable operation and even distribution of pressure on grinding disc. The use of a dust extraction vacuum with the dust guard and brush rim ensures a clean working environment and prolongs the life of the machine.

- Vibration reduction technology
- Remove paint, epoxy, glue and other hard coatings
- Smooth rough surfaces
- Clean concrete before applying new paint or coatings
- Collect dust for clean working area with a CS Unitec dust extraction vacuum

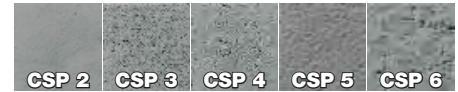

5" dia. Heavy-Duty
EBS 1802.1

7" dia.
EBS 180 H

Hand-Held Grinders

Model	EBS 1802.1	EBS 180 H
Power (110V)	16 Amp	20 Amp
Disc Dia.	5"	7"
Load Speed	10,000 RPM	9,500 RPM
Weight	12 lbs.	18 lbs.

Heavy-duty cap
impact resistant, robust

Ergonomic handles
comfortable operation and even distribution of pressure on grinding disc

Vibration reduction patented technology
dissipates vibration between motor and handle – low vibration protects the wrists of the user and offers improved grinding performance

Vertical motor position
motor is positioned above grinding wheel and dust extraction port for extended life

Edging dust guard
removable front edge to grind to edge of work area

Brush rim
protection against dust emission

Vacuum cleaner connection
port for dust extraction



Diamond Grinding Wheels

for Model	EBS 1802.1	EBS 180 H	EBS 180 F
General Use	37114	37111	37111
Uncoated (clear) Concrete	37102	37112	37112
PCD Grinding Wheel	37115	37119	37119

Walk-Behind Grinder, 7"

With angle-adjustable floor guide for medium-sized jobs

CS Unitec's walk-behind concrete grinders are ideal for grinding and smoothing concrete, screed, tile adhesive, paint and other coatings.

- Height-adjustable handle for operator comfort
- Foldable side edge of dust guard – for grinding directly to the edge
- Brush rim for collecting dust when connected to a dust extraction vacuum

Walk-Behind Grinder

Model	EBS 180 F
Power (110V)	20 Amp
Disc Dia.	7"
Load Speed	8,500 RPM
Weight	23 lbs.



Concrete Grinders

Walk-Behind Grinders, 10" and 20"

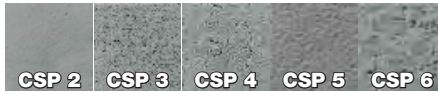

- Level high spots, remove coatings and adhesives, prepare for new coatings, polish concrete and more
- Flexible grinding head ensures maximum contact over rough surfaces
- Vibro-Lo™ vibration reduction for operator comfort and safety
- Optional weights for custom adjustment
- Dust ports for use with vacuum for virtually dust-free working



TCG 250 – 10" Grinding Width Heavy-duty single-head wet/dry grinder



Model	Power	Description	Model No.	Specifications
TCG 250	Gas	w/ Quick Release Plate	345.2400QR	Disc Diameter: 10" Load Speed: 1,070 RPM Weight: 198 lbs.
	120V, 1ph	w/Quick Release Plate	345.2342QR	
	230V, 1ph	w/ Quick Release Plate	345.2404QR	



TCG 500 – 20" Grinding Width Heavy-duty dual-head wet/dry grinder



Model	Power	Description	Model No.	Specifications
TCG 500	Gas	w/ Quick Release Plate	350.2400QR	Disc Diameter: 10" (uses 2 plates) Load Speed: 360 RPM Weight: 331 lbs. Vibration at Handle: 2.09 m/s ²
	120V, 1ph	w/ Quick Release Plate	350.2342QR	
	230V, 1ph	w/ Quick Release Plate	350.2404QR	



TCG 250 and 500 Grinding Abrasives and Accessories

TCG 250: uses one plate **TCG 500: uses 2 plates** **Abrasives are per piece**

Diamond Discs

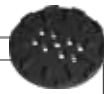

Model No.	Description
350.5610RA	10 Segment Soft Bond Grinding Disc
350.5616RA	16 Segment Soft Bond Grinding Disc
350.5620RA	20 Segment Soft Bond Grinding Disc
350.5610B	10 Segment Medium Bond Grinding Disc
350.5616B	16 Segment Medium Bond Grinding Disc
350.5620B	20 Segment Medium Bond Grinding Disc
350.5610R	10 Segment Hard Bond Grinding Disc
350.5616R	16 Segment Hard Bond Grinding Disc
350.5620R	20 Segment Hard Bond Grinding Disc

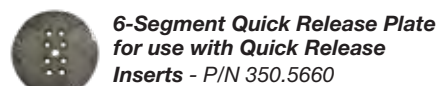

Removal Diamonds



Model No.	Description
365.5495L	PCD Removal Diamond Anti Clockwise Removal of coatings, adhesives & toppings
365.5495R	PCD Removal Diamond Clockwise Removal of coatings, adhesives & toppings
365.5500	16 Grit Single (Quick Release) Soft Bond Very coarse grinding & thin coatings removal
365.5500/2	Very coarse grinding & thin coatings removal

General Grinding & Leveling



Model No.	Description
365.5501	30 Grit Single (Quick Release) Soft Bond For hard concrete
365.5502	30 Grit Single (Quick Release) Medium Bond For medium hardness Concrete
365.5503	30 Grit Single (Quick Release) Hard Bond For soft concrete or very rough concrete
365.5501/2	30 Grit Double (Quick Release) Soft Bond For hard concrete
365.5502/2	30 Grit Double (Quick Release) Medium Bond For medium hardness concrete
365.5503/2	30 Grit Double (Quick Release) Hard Bond For soft concrete or very rough concrete

Fine Grinding



Model No.	Description
365.5504/2	70 Grit Double (Quick Release) Medium Bond For light grinding/scratch removal
365.5506/2	120 Grit Double (Quick Release) Medium Bond For light grinding/scratch removal

Polishing

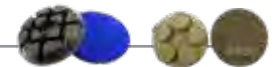

Model No.	Description
365.5605	50 Grit Hybrid
365.5610	100 Grit Hybrid
365.5620	200 Grit Hybrid
365.5602A	200 Grit Resin Bond
365.5604A	400 Grit Resin Bond
365.5608A	800 Grit Resin Bond
365.5618A	1500 Grit Resin Bond
365.5635A	3000 Grit Resin Bond

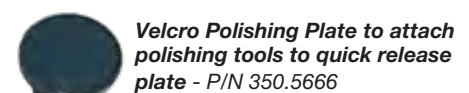

EOF 100 Power Milling/Paint Stripping/Shaving

Up to 5x faster than sanding concrete, wood, plaster and other surfaces
Remove varnish, paint, resins, coatings, solids, greasy dirt and more

- Mill directly to the edge – adjustable dust guard and flat front opening
- Precise depth adjustment: from 0.1mm to 1.0 mm for material removal without milling into the substrate
- Minimize exposure to unhealthy odors and hazardous chemicals when used with dust extraction vacuum
- Reduced vibration and increased operator comfort with a soft-grip, non-slip handle
- Electronic soft start, constant speed, speed reduction in case of overload and temperature/ overcurrent cut-off



Carbide milling disc for wood surfaces (P/N 37124000)

PCD milling disc for concrete surfaces (P/N 37125000)



Model EOF 100	
Power	9.6 Amp / 120 V
Milling Head	4"
Depth Adjustment	0.1 mm to 1.0 mm
Load Speed	10,000 RPM
Spindle Connection	M 14 Male
Weight	7 lbs.

* Milling Disc not included



EPF 1503 Scouring & Scarifying Machine

Remove plaster, paint and coatings – and roughen surfaces

- Electronic soft start, constant speed, speed reduction in case of overload and temperature/overcurrent cut-off
- Adjustable guide ring for precise depth adjustment
- Brush rim for dust-free working by connecting an industrial vacuum
- Non-slip, soft-grip handle – less vibration



Model EPF 1503	
Power	13.6 Amp / 110 V
Milling Head	5"
Depth Adj.	0.02" to 0.16"
Load Speed	4,000 RPM
Spindle	M 14 Male
Weight	10 lbs.

Accessory Cutters:

Claw Cutter, for adhesives, soft mortar and coatings Bent Teeth - 16 pcs. - P/N 37426

Star Cutter, for hard mortar and paint Straight Teeth - 16 pcs. - P/N 37427



Plaster Smoothing Machine

Smooth, scrape and clean plaster surfaces

- Stepless speed control
- 14-1/2" dia. disc for large surface areas
- Lightweight
- Balanced handles for easier gliding along the surface



Model EPG 400 WP is equipped with water supply for moistening of the wall with an atomized spray.



Model EPG 400 WP	
Power	5 Amp / 110 V
Disc Dia.	14-1/2"
Load Speed	0-60 RPM
No-Load Speed	110 RPM
Plate Connection	Velcro
Weight	7.7 lbs.

Accessories for Plaster Smoothing Machines

Base Plate (14-3/4" dia.) - P/N 37721
Sponge Disc (15-3/4" dia.) - P/N 37722
Sponge Rubber Disc (15" dia.) - P/N 37725
Scraping Disc (15" dia.) - P/N 37726

Sanding Disc (14-3/4" dia., 24 grit) - P/N 37727
Scratching Disc (14-3/4" dia.) - P/N 37724
Smoothing Disc (15" dia.) - P/N 37728
Felt Disc (14-1/2" dia.) - P/N 37729

Hand-Held and Rig-Mounted Core Drills

- Drill holes from 5/32" to 14" dia. in floors, walls and ceilings
- Fast drilling of reinforced concrete, concrete, brick, block and stone
- 5/8" and 1-1/4" standard thread connections
- Drills are equipped with a "slip clutch"
- Vacuum dust collection port attachment available

Wet and Dry Diamond Core Bits are available for concrete, stone, asphalt and more. Contact us for details.



Wet

END 712
Mini Diamond Drill for tile, natural stone and concrete
Drill holes 5/32" to 3/4"
0-8000 RPM

END 1550 P
Ideal for stone, tiles, ceramic porcelain, stoneware, and glass up to 2-5/8" dia. with tile bits. Concrete up to 1-1/2" dia. with standard core bits.
Drill holes up to 2-5/8"
1800-4400 RPM
Swivel suction stand available: BST 50V



Wet



Wet - 3-speed
END 130/3.2 PO
END130/3.2 POSA
END130/3.2 POSV
Drill holes up to 6"



END 130/3.2 POSV



Wet/Dry - 2-speed
ETN 2001 P
ETN 2001 PSA
ETN 2001 PSV
Drill holes up to 4"



Wet/Dry - 3-speed
ETN 162/3 P
ETN 162/3 PSA
ETN 162/3 PSV
Drill holes up to 6-3/8"
ETN 162/3 P182 VS/S
Drill holes up to 8"
Integrated dust collection port



Model No.	Motor Power (Amps)	Drilling Diameter	Load Speed (RPM)	Weight (lbs.)*	Drill with Anchor Stand Model No.	Drill with Anchor Stand & Vacuum Pump Model No.
END 712	6.3	5/32" to 3/4"	0-8000	5	N/A	N/A
END 1550 P	13	1/4" to 2-5/8"	1800-4400	7	N/A	N/A
ETN 2001 P	15	up to 4"	0-800/0-1570	15	ETN 2001 PSA	ETN 2001 PSV
ETN 162/3 P	19	up to 6-3/8"	0-510/0-1150/ 0-2500	15	ETN 162/3 PSA	ETN 162/3 PSV
ETN162/3 P182 VS/S	19	up to 8"	0-510/0-1150/ 0-2500	34	Model includes drill and BST 182 V/S anchor/vacuum stand for 8" dia. holes	
END 130/3.2 PO	15	up to 6"	600/1300/2800	16	END130/3.2 POSA	END130/3.2 POSV

* Weight is for hand-held models only. Please contact CS Unitec for weight information on drill rig combinations.

Note: Hand-held core drills are intended up to a max. of 3" dia. for hand-held drilling or up to 6" dia. with a stand.

Rig Mounted Core Drills



1-speed
DBE 201
 Rig mounted
 only
 Drill holes
 up to 8"



3-speed
EBM 352/3 P (motor only, for
 use with compatible stands)
EBM 352/3 PSA (anchor stand)
EBM 352/3 PSV (anchor vacuum
 stand)
 Drill holes up to 14"



Model No.	Motor Power (Amps)	Drilling Diameter	Load Speed (RPM)	Weight (lbs.)	Drill with Anchor Stand Model No.	Drill with Anchor Stand & Vacuum Pump Model No.
DBE 201	18	up to 8"	450	34	Included	N/A
EBM 352/3 P	24.5	up to 14"	230/500/1030	28**	EBM 352/3 PSA*	EBM 352/3 PSV*

* With spacer block – P/N 35827000 ** Weight is for motor only. Please contact CS Unitec for weight information on drill rig combinations.

Hydraulic and Pneumatic Core Drills

Hydraulic Core Drills

- Rugged 3-speed gearbox with mechanical slip clutch
- Ideal for heavy-duty wet drilling in concrete, reinforced concrete and asphalt
- Self-regulating oil flow control – required volume of 6 GPM; flow up to 13 GPM is automatically bypassed back to the tank
- Hose diameter: 1/2" ID Hose with 3/8" FF (HTMA) Couplings



Model
2 1317 0030



Model No.	Motor Power (HP)	Max Drilling Dia.	Free Speed (RPM)	Connecting Threads	Oil Flow/ 2000 PSI	Weight (lbs.)	Stand
2 1317 0030	3.6	3"	380/900/ 1800	1-1/4"x7 UNC Male 5/8"x11 UNC Male	6 GPM	16	Motor only
2 1317 0030 SA	3.6	6"				47	Anchor Stand
2 1317 0030 SV	3.6	6"				49	Anchor Stand & Vacuum Pump
2 1327 0010 SA	4.2	12"	380/900/ 1800	1-1/4"x7 UNC Male Optional: 5/8"x11	6 GPM	69	Anchor Stand
2 1327 0010 SV	4.2	12"	380/900/ 1800	1-1/4"x7 UNC Male Optional: 5/8"x11	6 GPM	82	Anchor Stand & Vacuum Pump

Note: Hand-held core drills are intended up to a max. of 3" dia. for hand-held drilling or up to 6" dia. with a stand.



Model
2 1327 0010 SA

Pneumatic Core Drills

- Rugged 3-speed gearbox with mechanical slip clutch
- Ideal for heavy-duty wet drilling in concrete, reinforced concrete and asphalt
- Pneumatic power for hazardous areas and Ex zones



Model 2 1333 0010

Model No.	Motor Power (HP)	Max Drilling Dia.	Load Speed (RPM)	CFM @ 90 PSI	Weight (lbs.)	Stand
2 1333 0010	2.1	3"	400/900/ 1600	77	18	Motor only
2 1333 0010 SA	2.1	6"			49	Anchor Stand
2 1333 0010 SV	2.1	6"			51	Anchor Stand & Vacuum Pump
2 1335 0010	3.8	3"	300/700/ 1350	123	21	Motor only
2 1335 0010 SA	3.8	6"			52	Anchor Stand
2 1335 0010 SV	3.8	6"			54	Anchor Stand & Vacuum Pump
2 1328 0050 SA	3.8	12"	300/700/ 1350	123	66	Anchor Stand
2 1328 0050 SV	3.8	12"	72		Anchor Stand & Vacuum Pump	

Note: Hand-held core drills are intended up to a max. of 3" dia. for hand-held drilling or up to 6" dia. with a stand.



Model 2 1328 0050 SA

ATEX Certified
For use in hazardous environments and ATEX and Ex Zones

Power Packs

Hydraulic Power Unit

Model P95

- Ideal for use with our hydraulic power tools
- Delivers 5 GPM or 8 GPM at 2000 PSI
- Easy to move with lift and latch handle
- Weighs 330 lbs.
- 18 HP gas engine



Hydraulic Power Unit is available with gas, electric or diesel engines. Contact us for more information.

AirPac Dryer/Cleaner

Model CSAP-2

- Removes moisture and dirt from air lines; float valve automatically ejects water and dirt
- Includes automatic oiler; protects tools from freezing in cold environments
- Eliminates air motor downtime caused by water and dirt
- Connections for two tools; max. air flow 185 CFM



Air Tool Lubricant

ProLube-ATL
P/N CS 7043-001 (gallon)

Air Tool Lubricant with Anti-Freeze

ProLube-ATL/AF
P/N CS 7049-001 (gallon)

Air Tool Line Conditioner/Cleaner

For use in underwater air tools – displaces moisture and inhibits rust and corrosion of air motors - P/N 9109 (5 liters)

Service Unit / Lubricator / Regulator

Model 9 2406 0630 (1/2" NPT) Model 9 2406 0650 (3/4" NPT)

- Portable filter, pressure regulator and lubricator
- Maintains constant downstream pressure for consistent tool operation
- Air pressure adjustable from 0-140 PSI
- Filter collects condensate, scale, rust, etc.
- Maximum air volume: 125 CFM
- Durable steel enclosure protects the unit



Core Drill Stands and Rigs



360° swivel range

BST 50V



BST 104/60V



BST 162 V



BST 182 V/S



BST 300



BST 300 V

Specifications	BST 50 V	BST 104/60V*	BST 162 V*	BST 182 V/S*	BST 300	BST 300 V*
Description	Swivel suction stand	Anchor/Vacuum stand	Anchor/Vacuum stand	Anchor/Vacuum stand	Anchor stand,	Anchor/Vacuum stand
Height	17"	30"	38"	41"	44"	44"
Weight	16 lbs.	21 lbs.	31 lbs.	31 lbs.	45 lbs.	50 lbs.
For use with Core Drill(s)	END 1550 P	ETN 2001 P END 130/3.2 PO	ETN 162/3 2 1317 0030 2 1333 0010 2 1335 0010	ETN 162/3	EBM 352/3 2 1327 0010 2 1328 0050	EBM 352/3 2 1327 0010 2 1328 0050

To add vacuum capability for electric and hydraulic core drills, order vacuum pump part no. 253 511; for pneumatic core drills, order vacuum part no. 253 542

Core Drill Rig for safer drilling in walls



- Ideal for higher-level drilling with hand-held drills
- Reduces risk of fatigue and accidents
- Simple assembly without tools
- Hydraulic foot-operated pump for easy height adjustment
- Equipped with casters for mobility at the job site

Model EBW 2300

Working Height	57" to 68"
Collar Diameter	2-1/3" / 60mm
Weight	88 lbs.

68" max. drilling height



Conveniently transport to the job site.

Optional Machine Arm

Allows working height of 12" to 57-1/2"

P/N 3582E000

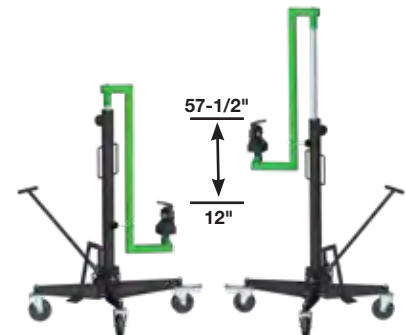

Air and Hydraulic Concrete Saws

Diamond Concrete Chain Saws – Pneumatic and Hydraulic

Air Powered



- Specifically designed for the demanding requirements of professional sawing and drilling contractors
- Deep plunge cuts – up to 20" deep
- Square corners up to 19" with no overcuts
- Cut mechanical openings and irregular shapes
- Flat shaft drive system (no Trantorque)

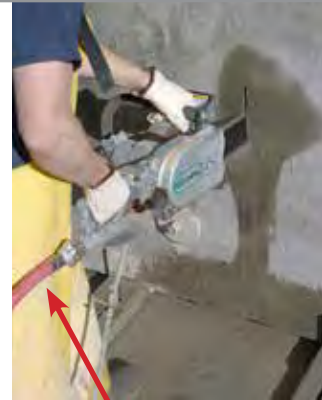

Air

Model No.	Power (HP)	No Load Speed (RPM)	Max. Depth of Cut	Motor Specifications	Weight w/ Bar and Chain	No Load Torque (in.-lbs.)	Noise Level at 3 ft.
Pneumatic Concrete Chain Saw							
CS 536664-1	6.5	5700	10"	124 CFM @ 90 PSI (6 bar)	32 lbs.	104	88 dB
CS 536664-2	6.5	5700	15"	124 CFM @ 90 PSI (6 bar)	33 lbs.	104	88 dB
CS 536664-3	6.5	5700	20"	124 CFM @ 90 PSI (6 bar)	34 lbs.	104	88 dB
Hydraulic Concrete Chain Saw							
CS 566110-1	11	5700	10"	8 GPM @ 2500 PSI (172 bar)	28 lbs.	95	88 dB
CS 566110-2	11	5700	15"	8 GPM @ 2500 PSI (172 bar)	29 lbs.	95	88 dB
CS 566110-3	11	5700	20"	8 GPM @ 2500 PSI (172 bar)	30 lbs.	95	88 dB

AirFORCE F4™ Diamond Chains

Optimized for air and hydraulic chainsawing – cut concrete with steel reinforcement

AirFORCE Premium Chains

10" – Part No. CC 01-2540

15" – Part No. CC 01-3810

20" – Part No. CC 05-5080

Guide Bars with Internal Water Feed

10" Guide Bar, for 25 segment Diamond Chain - P/N GB 01-2540

15" Guide Bar, for 29 segment Diamond Chain - P/N GB 03-3810

20" Guide Bar, for 34 segment Diamond Chain - P/N GB 05-5080

PowerGrit Diamond Air Saw for Ductile Iron



The PowerGrit system allows the user to perform the entire cut from one position – a feature especially helpful in reducing the amount of excavation required in underground cuts.



Model No.	Power (HP)	No Load Speed (RPM)	Max. Depth of Cut	CFM @90 PSI	Weight w/ Bar and Chain	No Load Torque (in.-lbs.)	Noise Level at 3 ft.
CS 536664-PG2*	6.5	5700	15"	124 CFM	32 lbs.	104	88 dB
CS 536664-PG3**	6.5	5700	20"	124 CFM	33 lbs.	104	88 dB

* For 15" PowerGrit Saw and Pipe Clamp – order no. CS 536664-PG2C

** For 20" PowerGrit Saw and Pipe Clamp – order no. CS 536664-PG3C

The PowerGrit Saw is also available with a hydraulic motor. Contact us for more information.

PowerGrit Chains and Clamp

15" PowerGrit Chain	P/N PG 52-3810
20" PowerGrit Chain	P/N PG 53-5080
PowerGrit Pipe Clamp (12" cap.; includes mounting axle)	P/N PG 56-9960

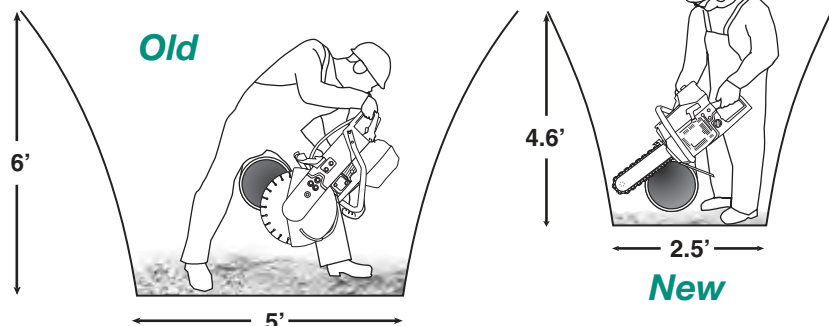

Pneumatic Concrete Saws – Hand-Held & Walk-Behind

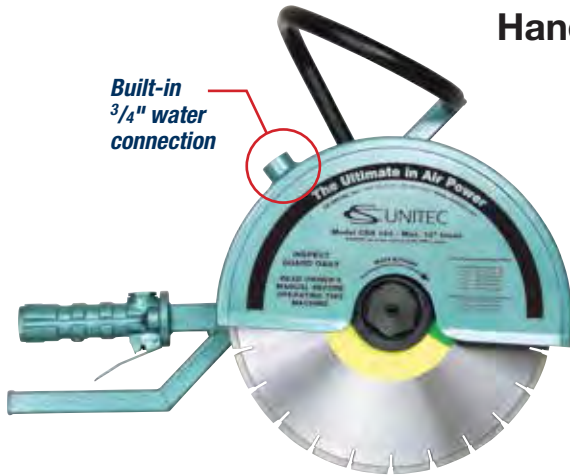

Built-in 3/4" water connection

Hand-Held Cut-Off Saws – 14" and 18"

- Wet or dry cutting of concrete, reinforced concrete, asphalt, masonry, steel and more
- Cut up to 7" deep with no gas or engine fumes
- Low maintenance – no belts, pistons, fuel lines or carburetors
- Accept diamond or abrasive blades
- Adjustable blade guard with built-in water connection
- In-line oiler for motor lubrication
- 1" arbor size, 1/2" NPT air connection

Cut-Off Saw with 14" abrasive blade



Model No.	RPM (No Load)	Max. Depth of Cut	Max. Blade Capacity	CFM @ 100 PSI	Drive	Weight (lbs.)
CSH 135	2900	5"	14"	92	Gearbox	32
CSH 160	2900	7"	18"	92	Gearbox	34

Walk-Behind Cut-Off Saw – 20" Capacity

- Wet or dry cutting of concrete, asphalt and other materials
- Cut up to 7" deep with no gas or engine fumes
- Low maintenance – no belts, pistons, fuel lines or carburetors
- Designed for tough cutting jobs, including joint sawing, floor sawing, trenching, road repair and plant maintenance
- Pneumatic motor with gearbox drive
- Rugged steel construction – yet only 112.5 lbs.
- Integrated dust extraction vacuum port
- Built-in water connection for wet cutting
- Built-in oiler for motor lubrication
- Optional water tank kit (p/n 278 010)



CSR-160

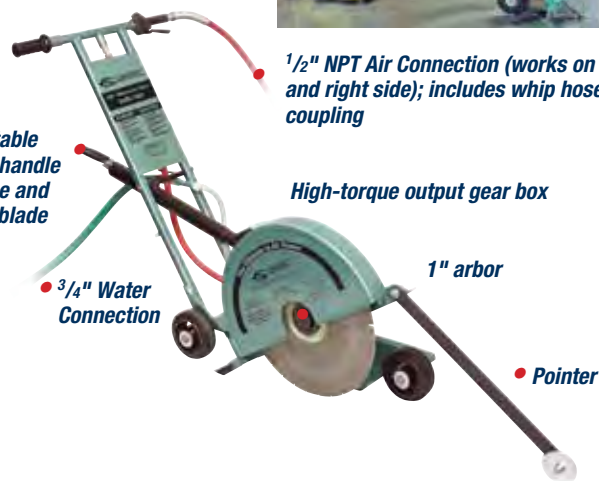

Model CSR-160	
RPM (No Load)	2900
Max. Depth of Cut	7"
Max. Blade Capacity	20"
CFM @100 PSI	92
Drive	Gearbox
Weight	112.5 lbs.



Diamond Cut-Off Saw Blades *Premium diamond blades for saws with 1" arbor*

- Cut cured concrete
- Special blades for cutting asphalt, ductile iron and green concrete also available

Model No.	Size	Model No.	Size
734 906 (wet or dry)	12" x .125" x 1"	734 909 (wet or dry)	18" x .125" x 1"
734 908 (wet or dry)	14" x .125" x 1"	734 910 (wet or dry)	20" x .125" x 1"
734 916 (wet or dry)	16" x .125" x 1"	RES.403 (rescue)	14" x .125" x 1"

734 916 ASPH	16" diamond blade for asphalt/green concrete
712 631	18" diamond blade for asphalt/green concrete
712 713	20" diamond blade for asphalt/green concrete

Air and hydraulic: powerful percussion drilling for concrete and masonry – even underwater

- SDS Plus or SDS Max models
- Safety clutch protects against overloading and jamming
- Hammer drill holes in concrete, brick and masonry
- Rotary drilling mode for straight drilling of steel and wood
- Open center hydraulic standard, closed center optional

SDS Max – Modes of Operation

2" bit capacity for drilling concrete and masonry

Hammer with Rotation
Ideal for concrete drilling

Rotation Only For drilling steel and wood (not reversible)



Air Model 2 2417 0010
SDS Max



Hydraulic Model
2 2418 0010
SDS Max

Second handle position
SAE #8 port for hydraulic hose connection

Closed Center Flow Control Valve

Optional accessory – Part No. 38632



SDS Drill Bits



Small Masonry Bits
SDS Plus up to 1" dia.



Large Masonry Bits
SDS Max up to 2" dia.

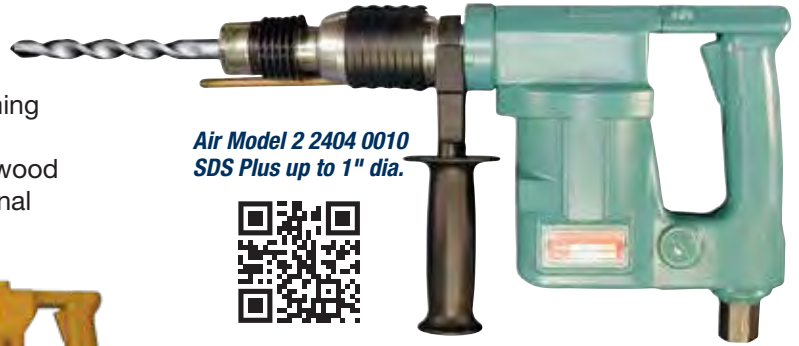

Air Model 2 2404 0010
SDS Plus up to 1" dia.



SDS Plus – Hammer and Drill

1" bit capacity for drilling concrete and masonry

Drill concrete anchor holes, thru holes, piping and mechanical openings for construction and repair work. Switches to rotary drilling mode for steel and wood.



Hydraulic Model
2 2426 0010
SDS Plus
Pressure reducing valve integrated into handle

SAE #8 oil port

1/2" chuck with SDS+ shank
Part No. 2 2409 8999

1/2" chuck with SDS Max shank
Part No. XRDCMKL 12

Pneumatic Hammer Drill Model No.	Blows/Minute (BPM)	Drill Speed (RPM)	Solid Bit Capacity (concrete)	Core Bit Capacity (concrete)	Twist Drill (wood)	Motor Power (HP)	CFM at 90 PSI	Tool System	Dimensions (inches)	Weight (lbs.)
2 1266 0010	0-2000	0-950	1/2" dia.	1" dia.	3/8" dia.	0.75	21	1/2" Chuck	12 x 8 1/2 x 4	7
2 2404 0010	0-3000	0-625	1" dia.	3" dia.	3/4" dia.	0.70	21	SDS Plus	16 x 8 1/2 x 4	11
2 2404 0030*	0-3000	0-625	1" dia.	3" dia.	3/4" dia.	0.70	21	SDS Plus	16 x 8 1/2 x 4	11
2 2417 0010	0-2500	0-250	2" dia.	6" dia.	1 1/4" dia.	1.60	53	SDS Max	19 1/2 x 9.8 x 4 1/2	26

* Underwater model with exhaust valve port pointing away from user's work area and line of sight. Optional underwater air tool line conditioner to displace moisture, Part No. 9109 (5 liters).

Hydraulic Hammer Drill Model No.	Blows/Minute (BPM)	Drill Speed (RPM)	Solid Bit Capacity (concrete)	Core Bit Capacity (concrete)	Twist Drill (wood)	Motor Power (HP)	Oil Flow/PSI	Tool System	Dimensions (inches)	Weight (lbs.)
2 2426 0010**	0-3400	0-625	1" dia.	3" dia.	3/4" dia.	0.8	5.8-13.2 GPM @ 1160 PSI	SDS Plus	18 x 10 1/4 x 4	15
2 2418 0010	0-2500	0-250	2" dia.	6" dia.	1 1/4" dia.	1.8	2.6-13.2 GPM @ 1160 PSI	SDS Max	16 x 8 1/2 x 4	11
2 2418 0020	Same as 2 2418 0010 above. Includes 2 2406 9700 Pressure Reducing Valve for 2000 PSI.									

Hydraulic Hammer Drills operate at hydraulic pressures of 1160 PSI max. Pressure reducing valves are available to reduce pressure from 2000 PSI or 5000 PSI. Available with optional closed center. Hydraulic Hammer Drills supplied with whip hoses and flush face couplers.

** Pressure relief valve is built into the handle

Wet/Dry 8" Electric Circular Saw



- Wet and dry cutting of stone and masonry materials, including granite, marble, terrazzo and concrete
- Adjustable cutting depth up to 3" for precise cuts
- Ideal for landscapers, renovators and stone shops
- Vacuum connection for use with CS Unitec's dust extraction vacuum systems (see pg. 21)
- Optional blade: P/N 37444000 – 8" blade with 3" max. depth of cut



Model EDS 181

Power	20 Amp / 110 V
Max. Blade Diameter	8"
Max. Depth of Cut	3" (with 8" blade)
Load Speed	4,300 RPM
No-Load Speed	7,500 RPM
Weight	17 lbs.
7" Blade (included)	P/N 37443000



Dust collection port for use with dust extraction systems



Miter adjustment up to 45° – no tools required



Optional guide rail for precise cuts

29" length – P/N 37461000
50" length – P/N 37462000

Wall Slotter/Wall Chaser

Cut channels and parallel grooves in walls and floors



- Ideal for milling channels for laying cable, conduit or pipe
- Essential tool for electricians, plumbers and other contractors
- Cut two parallel grooves up to 2²/₅" wide x 2²/₅" deep
- Compact with parallel grips for easy handling
- Works as close as 5/8" from the edge or corner
- Closed vacuum hood for efficient dust collection, and easy removal of fragments through vacuum hose lock
- Motor overload protection with optical overload indicator

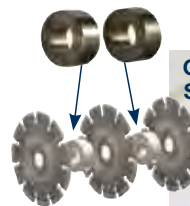

Optional Spacer Set for 3-blades
(P/N 3744S000)



3 BLADES FOR UP TO 30% FASTER BREAKOUT



Model EMF 180.2

Power	20 Amp / 110 V
Blade Diameter	7"
Max. Slot Width	2-2/5" (60mm)
Max. Milling Depth	2-2/5" (60mm)
Load Speed	2200 RPM
No-Load Speed	3100 RPM
Arbor Size	7/8"
Weight	16.5 lbs.

Standard Equipment:
2 premium diamond blades (p/n 37443000), carrying case and spanner wrench.



Dust collection port for use with dust extraction systems



5" Diamond Saw for Tile and Stone

**Model EDS 125
for wet/dry cutting**



- Wet and dry cutting of tile, natural stone and stoneware
- Stepless miter adjustments up to 45° – no tools required
- Roller guide smoothly guides saw and protects surface
- Adjustable cutting depth up to 1-3/8"
- Integrated water supply with flow regulator easily adjusts water volume for dust-free working while wet cutting
- Vacuum connection for use with CS Unitec's dust extraction vacuum systems (see pg. 21)



Integrated water supply with flow regulator



Dust collection port for use with dust extraction systems



Optional cutting table – ETT 700 and ETT 1200 (see below)



Stepless miter adjustments up to 45° – without tools



5" Diamond Blade included (P/N 3744B000) for wet/dry cutting

Model EDS 125

Power	11.4 Amp / 110 V
Blade Diameter	5"
Max. Depth of Cut	1-3/8"
No-Load Speed	12,000 RPM
Arbor Size	7/8"
Weight	6.4 lbs.

Optional blades:

P/N 3744C000 – 5" Diamond blade for 1/4" milling, wet/dry
P/N 3744A000 – 4-1/2" Diamond blade for cutting curves, wet/dry

Cutting Tables for use with the EDS 125



- Rust-proof, lightweight and easily transportable to the job site
- Precise cutting of tiles up to 3/4" thick with EDS 125 saw
- Adjustable angle stop for miter cuts up to 45°



Easily transportable

Models	ETT 700	ETT 1200
Cutting Length	28"	47"
Weight	32 lbs.	39.7 lbs.

Quickly attach the EDS 125 to the table without tools



Dust Extraction Vacuums

See page 21



Professional, Heavy-Duty, Hand-Held Mixers for Fast, Efficient Mixing



From self-leveling cements to prefab mortar, CS Unitec has a portable mixer to do the job quickly. Every CS Unitec mixer has been designed for high reliability, with the power to provide optimum blending of construction materials on the job site.



Features that Make CS Unitec Mixers the Best Tools for the Construction Industry:

Soft Start and Variable Speed for less splashing and better control.

High-torque Motors with Specially Designed Gears provide maximum power. Mix quantities from 1 gal. to 290 lbs., including aggregate and other materials.

Helical Paddles mix from the bottom up, eliminating injection of air for an optimum blend.

Versatile Construction can be used hand-held or with our portable mixing stands.

Ergonomically Designed Metal Frame and Larger Handles

robust construction and balanced grip ensure comfortable handling

Integrated Rubber Handle Bumpers

protect mixer and tile/cementitious surfaces if mixer is dropped

Construction-grade Cable

for heavy-duty use

Fiberglass Housing –

lightweight, robust, reinforced outer housing

Weather Sealed Electronics

dust- and splash-resistant switches

Paddle Thread Connection

H-handle Configuration

protects motor against damage

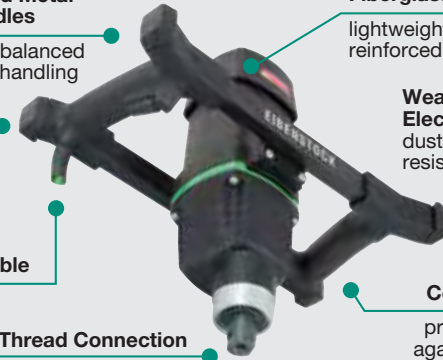

Job Size



Small

Tile cement, plaster, mortar, paints, epoxy and coatings.

Medium

Ideal for medium- to high-viscosity powder and liquid materials. Examples include finished plaster, latex, mortar, epoxy, self-leveling compounds and other materials.

Medium/Large

High-viscosity materials ranging from epoxy, mortars, plasters and cement to quartz-containing resins and flooring compounds, as well as insulation. Thoroughly mixes a wide variety of demanding materials.



EHR 18 S
Includes WG 120 paddle



EHR 20.1 R Set
Includes MG 140 paddle

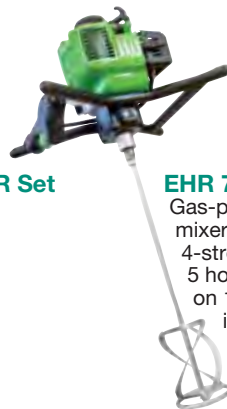

EHR 750 B
Gas-powered mixer with 4-stroke engine – 5 hour runtime on 1 gallon, includes MG 140 Paddle

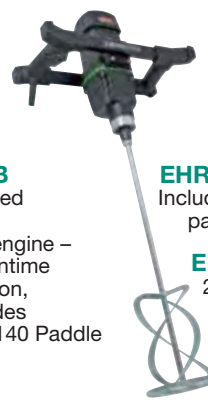

EHR 23/1.4 R
Includes MG 160 paddle

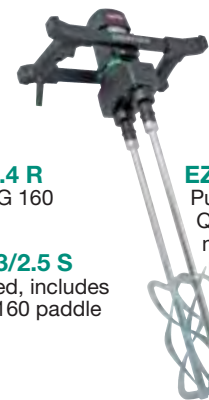

EZR 24 R R/L
Push-Pull Mixer: Quick, thorough mixing with twin paddles and clockwise/counterclockwise rotation – includes paddles

EHR 23/2.5 S
2-Speed, includes MG 160 paddle





Model No.	Motor Power	Load Speed	Capacity	Max. Output	Weight	Suitable Paddles
EHR 18 S	9.5 Amps	0-450 RPM	2 bags/20 gal.	700 lbs./hr.	9 lbs.	WG 120 MG 120 RG 120
EHR 20.1 R Set	10.5 Amps	250-580 RPM	3 bags/25 gal.	900 lbs./hr.	11.5 lbs.	WG 135 MG 140 TWP 140
EHR 23/1.4 R	14.5 Amps	100-275 RPM	5 bags/25 gal.	1800 lbs./hr.	15 lbs.	WG 160 MG 160 TWP 160
EHR 23/2.5 S 2-Speed	14.5 Amps	0-250/ 0-580 RPM	5 bags/25 gal.	1800 lbs./hr.	15 lbs.	WG 160 MG 160 TWP 160
EZR 24 R R/L Twin Paddle	14.5 Amps	180-440 RPM	5 bags/25 gal.	1800 lbs./hr.	17 lbs.	P/N 31630000 (set of two)
EHR 750 B Gas-Powered	1 HP	0-450 RPM	3 bags/25 gal.	900 lbs./hr.	19.6 lbs.	WG 135 MG 140 TWP 140

Mixing Paddles

Heavy-Duty Galvanized Steel Mixing Paddles

Helical design mixes from the bottom up, eliminating air pockets

- 14mm thread connection
- 24" paddle length

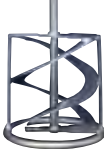
Low Viscosity	Medium Viscosity	High Viscosity	Fold & Stir	Overlays & Colored Products
Liquid materials including wall paints, lacquers, cement paints, chemicals, coating compounds and laitance	Tenacious materials such as finished plaster, mortar, gypsum, lime, floor compounds, granulates and quartz-filled epoxy resin	Finished mortar, finished plaster, floor compounds, refractory cements, insulating materials and quartz-filled epoxy resin.	Drywall mud and textured products, decorative concrete coatings and comparable products. Works in 5- to 55-gallon drums.	Wide range of under/overlays and powder/liquid colored products. For dry-bag compounds, cement/acrylic plasters, grout, and premixed products
				
RG 120 4.5" dia.	WG 120 4.5" dia. WG 135 5.4" dia. WG 160 6.25" dia.	MG 120 4.5" dia. MG 140 5.6" dia. MG 160 6.25" dia. MG 235 9.25" dia.	MH 240 9.625" x 6.25"	TWP 140 5.5" dia. TWP 160 6.375" dia. 28" length

* For all CS Unitec Mixers, order 14mm male thread paddles

Mixing paddles with 1/2" hex shank available for standard drill chucks



Also Available: Stainless Steel Paddles (for food grade applications)

Paddle Accessories:

32210000 9" long x M14

32142999 5/8" 3-jaw chuck with M14 adapter to fit any mixer

31630000 Paddle pair for EZR 24 R/R/L (9" working width.)



Portable Mixing Stand - Save time by running mixers independently

Model 25GP-WD

Designed for easy set up, with no clamping required. Has rear wheels for extra portability. Ideal for use with 5 gallon pails.

Size: H-35"
L-26"
W-14"
Weight: 64 lbs.



Pneumatic-powered Mixers for Hazardous Environments



Three air-powered models are inherently safer for mixing paint, glue, epoxy, mortar, concrete, refractory cement and other materials in shipyards and the oil and gas industries. They can be used around water with no fear of shock or blown circuitry.



The MEGA HIPPO portable mixing station is also available with a pneumatic motor. Contact CS Unitec for details.



Model No.	Motor Power	CFM @ 90 PSI	Load Speed (RPM)	Max. Output	Weight	Air Connection	Suitable Paddles
7 1111 0010	1.5 HP	49	0-440	110 lbs./hr.	14 lbs.	3/8"	MG 140
7 1112 0010	1.5 HP	49	0-190 / 0-350	110 lbs./hr.	5 lbs.	3/8"	MG 140
7 1113 0010	2.2 HP	67	0-190 / 0-420	200 lbs./hr.	23 lbs.	3/4"	MG 160, WG 160

ATEX-Certified models available. Contact CS Unitec for more information.

Industry Standard System for Self-Levelers!

NEW 20 AMP MOTOR: MAINTAIN HIGHER SPEEDS!
 Now handle a wider range of materials – mix thicker compounds and heavier aggregate



✓ **New 3-speed motor with 33% more power**
 Higher torque for use with even more materials, including thicker compounds and heavier aggregate

✓ **Large batch capacity**
 Thoroughly mix batches up to 6 bags (23 gallons/350 lbs.) of self-levelers

✓ **Reduced dust and splatter**

✓ **Replaceable liners**
 Increase productivity and eliminate cross-contamination

✓ **Balanced tilting cradle**
 For easy, smooth pouring

✓ **Slim profile & compact height**
 Easily maneuver through doorways and transport between jobsites, even in enclosed trucks and vans

Heavy-Duty
 Aluminum
 Gear Knob



Self-Leveling Over/Underlayments • Engineered Concrete • Cement Screeds
 Sealants • Adhesives • Resins • Epoxies • Textured Coatings • Slurries • and more

Cost Savings Example when using the HIPPO Mixing System:

Reduce labor costs by up to 86% **Increase output by up to 11x!**

2 People + 2 Buckets + 1 Mixer	9 bags/hour output \$4.44 cost per bag (labor)	
2 People + 1 Barrel + 1 Mixer	26 bags/hour output \$1.54 cost per bag (labor)	
3 People + 2 Barrels + 2 Mixers	50 bags/hour output \$1.20 cost per bag (labor)	
3 People + 2 HIPPOs + 1 Pelican Transport Cart	100 bags/hour output \$0.60 cost per bag (labor)	

A flexible solution for self-leveling jobs of all sizes!

Configure your ideal HIPPO System to maximize profit, increase output and boost your bottom line.



- PMH80F-DC3.1** Ideal for flat floors. Allows accurate placement - pour and spread at the same time. 4 casters.
- PMH80X-DC3.1** Ideal for rough terrain. Increased height - pour directly into buckets or carts. 2 tires/2 legs.
- PMP80** Pelican cart and canister. Ideal for transporting and pouring materials and mixing back-to-back batches.

MEGA HIPPO Mixing System



**NEW MODEL:
PMH80F-DC3.1**

PORTAMIX® MEGA HIPPO

Capacity	6 Bags
Output	Up to 2200 lbs./hour
Speeds	175/300/430
Weight	109 lbs.
Paddles	2 included

Standard equipment included: Standard Equipment includes: mixing motor (PH 2516 R), bucket, removable liner (PH705), canister cover with hinged lid (PH718) and 2 paddles – TW225 for half batches (2-3 bags) and TW225D for full batches (4-6 bags)

**NEW MODEL:
PMH80X-DC3.1**



Replaceable Liners improve productivity, reduce cleanup, and eliminate cross-contamination

Fits both HIPPOs and Pelican Carts

Extends life of canister

Avoid flash-cure on fast setting materials

PH705



Rolled edge reduces compound seeping between liner and canister

Alternating liners prevents cross-contamination

Flexible and durable – dry compounds are easily broken up and removed by compressing liner



PH723
Optional lid with material chute



Pelican Transport Cart PMP80

Ideal for transporting and pouring materials and mixing back-to-back batches.



Pelican Mixing Station with Dust Control

For smaller jobs – mix, transport and pour up to 3-bag batches



- Canister cover and dust extraction port reduces airborne dust and splatter
- Powerful 2-gear variable-speed motor – can also be used for hand-held mixing
- Ideal for "assembly line" mixing – run multiple batches with PMP80DC-23 and 2+ PMP80 Pelican Carts



Model No. PMP80DC-23	
Capacity	3 Bags
Output	Up to 1500 lbs./hour
Power	14.5 AMP / 110 V
2-Speeds	0-250 and 0-580 RPM
Weight	65 lbs.
Paddles	2 included

Standard equipment included: EHR 23/2.4 Mixing Drill, 2 paddles (TK200P and MG 160), transport cart, canister, liner, canister cover with hinged lid and motor mount (PP650). For replacement liner, order part no. PH705.

Canister cover for reduced airborne dust and reduced splatter



Pelican Mixing Station includes EHR 23/2.4 S mixer – hand-held mixing drill can also be used for applications that don't require the canister.



Replaceable Liners improve productivity, reduce cleanup, and eliminate cross-contamination

PH705 Canister Liner

Fits both HIPPOs and Pelican Carts

Extends life of canister

Avoid flash-cure on fast setting materials



Rolled edge reduces compound seeping between liner and canister

Alternating liners prevents cross-contamination

Flexible and durable – dry compounds are easily broken up and removed by compressing liner



HIPPO and Pelican Accessories:

PMP80 Pelican Transport Cart & Canister

Transport and pour materials and mix back-to-back batches.



PH723 Lid with Material Chute

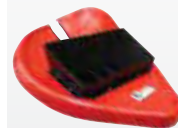

PP600 Hand-Held Mixer Clamp for PMP80 Pelican Mixing Cart

Clamp for PMP80 only, attaches to the Pelican Cart frame to mount a hand-held mixer



The **TWINMIX 1800** allows one user to automatically mix a new batch while pouring the previous batch – without sacrificing quality

CUT LABOR AND PRODUCTION TIME IN HALF
when using **TWINMIX** with an **Extra Cart!**

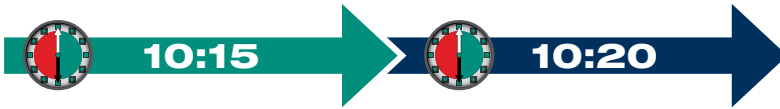

Timer automatically controls mixing time from 30 seconds to 12 minutes

IDEAL FOR HIGHLY VISCOUS MATERIALS, INCLUDING:
**MORTAR • STUCCO
GROUT • CONCRETE
AND MORE**

Improve mix results, increase profits and maximize productivity with TwinMix 1800

Reduce airborne dust and splatter while adding and mixing materials: integrated hood with safety switch, top load chute and vacuum port for cleaner, safer jobsite

Reduce material costs: contra-rotating paddle with scraper for clump-free, homogenous mixes

Accurately control batch time for consistent mix results: included timer shuts motor off

Prevent cross contamination: replaceable heavy-duty bucket allows for easy material changeover and fast clean-up



Two TwinMix options for maximum efficiency:

TwinMix 1800 TFR

(Order No. TwinMix 1800 TFR)

1 transport cart with 2 wheels and mixing bucket.



TwinMix 1800 TSD

(Order No. TwinMix 1800 TSD)

1 side-tip transport cart with 4 wheels for simultaneous pouring and spreading, and mixing bucket.



TwinMix 1800 Specifications

Power	15 Amp/110 V
Bucket Capacity	17 gal.
Helical Mixing Paddle	250/450 RPM
Scraper Paddle	20/36 RPM
Weight	155 lbs.

Standard equipment included: motor on stand, helical mixing paddle, scraper paddle, plastic edge scraper, mixing bucket and cart.



Tires for easy transport around the jobsite

Accessories:



Side-Tip Pouring Cart
(P/N 32332000)

Transport Cart
(P/N 32333000)

Replaceable Bucket
(P/N 32341)

Kit Options:

TwinMix 1800 TFR Kit 1
(Order No. TwinMix 1800 TFR Kit 1)
includes 2 transport carts

TwinMix 1800 TSD Kit 1
(Order No. TwinMix 1800 TSD Kit 1)
includes 2 side-tip carts



Underwater and Specialty Tools - Hydraulic & Air

Ideal for Industrial, Subsea, Mining, Utility, Demolition and Construction applications, including Ex Zones and Hazardous Environments

Portable Reciprocating Saws – Hand-Held or Clamp-On Cutting

Ideal for a wide range of industries, including subsea, gas utilities, offshore oil, petrochemical, power generation, industrial plant maintenance and construction

- Fast cutting of pipe, structural steel, bolts, nails, pallets and other material
- The best power-to-weight ratios in the industry; compact size for cutting in confined spaces



The CAT Model 5 1217 0020

1.3 HP, Cuts steel pipe and channel 1/2" to 6" dia., plastic pipe to 8" dia.



AIR **ATEX Certified**

CAT Saw Kit (5 1217 0070) includes saw, 4" and 6" pipe clamps (model nos. 563 100 and 563 200), case and five No. 1001 heavy-duty blades.



The SHARK Model 5 1219 0010

2 HP, cuts pipe up to 6" dia., wood up to 8" dia., metal plate up to 3/4" dia.



HYDRAULIC **ATEX Certified**

SHARK Saw Kit (5 1219 0070) includes saw, 4" and 6" pipe clamps (model nos. 563 100 and 563 200), case and five No. 1001 heavy-duty blades.



Model Number	Motor Specifications	Stroke Length	Strokes per Minute	Connection	Length	Weight (lbs.)
The CAT – Pneumatic						
5 1217 0020	1.3 HP, 46CFM @ 90 PSI	1-1/8"	0-1800	1/2" NPT (ID)	16"	9
The SHARK – Hydraulic						
5 1219 0010	2 HP, Oil Pressure 2000 PSI, Oil Flow 6 GPM (up to 13 GPM)	1-1/8"	1700	M 18 x 1.5 Female	18"	13.2

Reciprocating Saw Blades and Accessories

Extra-Thick Heavy-Duty Blades for 90° Cutting with a Pipe Clamp, Double Shank*

Much thicker than standard blades with a stronger double-tang mount for heavy-duty cutting, either free-hand or with a clamp.

Ask for special blades to cut steel.

No. 1001	up to 2" dia. pipe	8 TPI	6" L x 1" W x .060" T
No. 1002	up to 4" dia. pipe	8 TPI	8" L x 1" W x .060" T
No. 007D/200*	up to 4" dia. pipe	M-Tooth	8" L x 1" W x .050" T

* 007D/200 has universal 1/2" tang

Pipe Vise Clamps for 90° Cutting

Cut faster by increasing your leverage 5x while safely securing the saw.

For 1/8" - 2" Pipe: Model No. 563 000

For 2 1/2" - 4" Pipe: Model No. 563 100

For 4" - 6" Pipe: Model No. 563 200



Heavy-Duty HSS Bi-metal Blades for Freehand Sawing, Double Shank

Made of tough, resilient steel with 10/14 variable tooth pitch. Large blade width and double-shank mount for excellent cutting performance and durability.

No. 1005	10/14 TPI	6" L x 1" W x .035" T
No. 1003	10/14 TPI	8" L x 1" W x .035" T
No. 1004	10/14 TPI	12" L x 1" W x .035" T

Mega Sharp M-Tooth Saw Blades for Freehand Cutting with Standard 1/2" Shank

CUTS 2x FASTER THAN ORDINARY BLADES! M42 Bi-metal for cutting steel and stainless steel

Metal up to 1/8" Thick

No. 006/150	M-Tooth	6" L x 3/4" W x .035" T
No. 006/200	M-Tooth	7" L x 3/4" W x .035" T

Metal 1/8" and Thicker

No. 007/150	M-Tooth	6" L x 3/4" W x .035" T
No. 007/200	M-Tooth	8" L x 3/4" W x .035" T
No. 007/280	M-Tooth	12" L x 3/4" W x .035" T



Underwater and Specialty Tools - Hydraulic & Air

Ideal for Industrial, Subsea, Mining, Utility, Demolition and Construction applications, including Ex Zones and Hazardous Environments

Power Hackaws – Cold cut large pipe up to 30" dia. and structural steel

Ideal for a wide range of industries, including subsea, gas utilities, offshore oil, petrochemical, power generation, industrial plant maintenance and construction

- Cold cutting of large pipe, structural steel, tanks, profiles and more
- Compact size for cutting in confined spaces
- Accessories include wide variety of heavy-duty blades and clamps for 90° cuts



MODEL 5 1230 0050

- Ideal for use in nuclear power plants, underwater, and on sensitive jobsites
- Fully sealed gearbox
- Round connecting rod for balanced operation and minimized bearing wear



Model No.	Power	Throttle	Motor Specifications	Strokes per Min.	Blade Stroke	Hose	Wt. (lbs.)
Pneumatic – 3/4" ID NPT Air Connection							
5 1212 0010	1.5 HP	Roll	Air Consumption: 51 CFM Air Pressure: 90 PSI	100-350	2 ³ / ₈ "	1/2"	15.4
5 1212 0050	1.5 HP	Lever		100-350	2 ³ / ₈ "	1/2"	15.4
Hydraulic – 1/2" FF (HTMA) Couplings							
5 1220 0050	3.8 HP	Lever	Oil Flow: 4 GPM at 2000 PSI	100-500	2 ³ / ₈ "	1/2" ID	23
Hydraulic with Fully-Sealed Pistons and Gearbox – 1/2" FF (HTMA) Couplings							
5 1230 0050	3.8 HP	Lever	Oil Flow: 4 GPM at 2000 PSI	100-500	2 ³ / ₈ "	1/2" ID	24.25

Hacksaw Blades – 8" to 37" length

Order No.	Length	Teeth/Inch	Thickness	Material	Max. Cut
Z22-9 HSS	8"	8	1/16"	Steel/Aluminum	3 ¹ / ₈ " dia.
Z22-10 HSS	8"	16	1/16"	Steel	3 ¹ / ₈ " dia.
Z22-11 HSS	8"	24	1/16"	Sheet Metal	3 ¹ / ₈ " dia.
Z22-6 HSS	12"	16	1/16"	Steel	6 ⁵ / ₈ " dia.
Z22-6 HSS-SL*	12"	16	1/16"	Stainless Steel	6 ⁵ / ₈ " dia.
Z22-31 HSS	12"	12	1/16"	Steel	6 ⁵ / ₈ " dia.
Z22-7 HSS	16"	16	1/16"	Steel	10 ⁵ / ₈ " dia.
Z22-29 HSS	16"	8	1/16"	Steel/Aluminum	10 ⁵ / ₈ " dia.
Z22-33 HSS	16"	6	1/16"	Cast Iron	10 ⁵ / ₈ " dia.
Z22-72 HSS	20"	14	5/64"	Steel	14 ⁵ / ₈ " dia.
Z22-30 HSS	21"	12	1/16"	Steel	15 ⁵ / ₈ " dia.
Z22-30 HSS-SL*	21"	12	1/16"	Stainless Steel	15 ⁵ / ₈ " dia.
Z22-73 HSS	24"	14	5/64"	Steel	18 ¹ / ₂ " dia.
Z22-74 HSS	24"	8	5/64"	Steel/Aluminum	18 ¹ / ₂ " dia.
Z22-75 HSS	30"	12	5/64"	Steel	24 ⁷ / ₈ " dia.
Z22-75 HSS-SL*	30"	12	5/64"	Stainless Steel	24 ⁷ / ₈ " dia.
Z22-76 HSS	30"	6	5/64"	Cast Iron	24 ⁷ / ₈ " dia.
Z22-37 HSS	37"	12	5/64"	Steel	31 ⁷ / ₈ " dia.

* Use HSS-SL Blades for best cutting performance on stainless steel and hard metal. Blades for plastic, wood and masonry also available.

Hacksaw Clamps and Blade Guides

Model No.	Cutting Diameter	Description
5 1207 9910	2" to 6"	Pipe Clamp
5 1202 9960	4" to 12 ³ / ₄ "*	Pipe Clamp
5 1207 9970	Up to 13" OD	Blade Guide
5 1207 8910	Up to 21" OD	Blade Guide
5 1207 8970	21 ⁵ / ₈ " x 11 ³ / ₈ "	Profile Clamp
5 1208 9980	Up to 12 ³ / ₄ "*	Automatic - Self-feeding Clamp (for air saws)
5 1208 9990	Up to 12 ³ / ₄ "*	Automatic - Self-feeding (for hydraulic saws)



Model 5 1202 9960 Pipe Clamp for 4" to 12³/₄" dia.*

Model 5 1208 9980 Self-feeding Pipe Clamp for up to 12³/₄" dia. pneumatic saws*



Model 5 1208 9990 Self-feeding Pipe Clamp for up to 12³/₄" dia. electric and hydraulic saws*



* Cut up to 30" OD with two extension chains (order 2x P/N 5 1201 9030)

Underwater and Specialty Tools - Hydraulic & Air

Ideal for Industrial, Subsea, Mining, Utility, Demolition and Construction applications, including Ex Zones and Hazardous Environments

Portable Band Saws – On-site cutting of pipe up to 8" dia.

Cold cutting saws for industry, including refineries, chemical plants, utilities, construction, offshore oil, mining, marine and demolition

- Fast, deep, cold cutting of pipe, conduit, bolts, cable, angle iron, structural steel, chain and more
- Cut steel, stainless steel, Inconel, chrome, Hastelloy, aluminum, copper, iron, fiberglass, plastics, wood and more
- Vise clamps available for straight cutting of round, square and angular materials



Pneumatic AirBand™ Saws



Standard:
Cut 4 3/4" round or 4 1/2" x 4 3/4"



5 6093 0010:
Cut 4" round or 4" x 4"
Includes stationary cutting table and vise



Deep Throat™:
Cut 7" round or 7" x 7"

Wide Mouth™:
Cut 8" round or 9" x 8 1/2"

Hydraulic Band Saws



Standard:
Cut 4" round or 4" x 4"

Deep Throat™:
Cut 7" round or 7" x 7"

Wide Mouth™:
Cut 8" round or 9" x 8 1/2"

Pneumatic Band Saws

Model No.	Cutting Capacity	Motor Power	Blade Speed (ft/sec)	Overall Length	Wt. (lbs.)
Standard AirBand™ – Aluminum Housing; 1/4" NPT ID Air Connection; 3/8" Air Hose					
5 6003 0011	4 3/4" OD / 4 1/2" x 4 3/4"	90 PSI @ 20 CFM	2.2-3.3 (var.)	21 1/2"	14
5 6093 0010	4" OD / 4" x 4"	90 PSI @ 19 CFM	5.75	25"	17*
Deep Throat™ AirBand – Stainless Steel housing; 1/2" NPT ID Air Connection; 1/2" Air Hose					
5 6031 0010 N	7" OD / 7" x 7"	90 PSI @ 43 CFM	4.0-4.9 (var.)	28 3/4"	28
Wide Mouth™ AirBand – Stainless Steel housing; 1/2" NPT ID Air Connection; 1/2" Air Hose					
5 6062 0010	8" OD / 9" x 8 1/2"	90 PSI @ 43 CFM	4.0-4.9 (var.)	30 3/4"	35

* Weight of saw only. Weight of saw, stationary cutting table and vise is 48 lbs.

Hydraulic Band Saws

1.6 HP; Oil Flow: 4 GPM @ 2000 PSI; 1/2" FF (HTMA) Couplings

Model No.	Cutting Capacity	Blade Speed (ft/sec)	Overall Length	Wt. (lbs.)
Standard – Stainless Steel housing				
5 6043 0010	4" OD / 4" x 4"	4.2	22"	23
Deep Throat™ – Stainless Steel housing				
5 6041 0010	7" OD / 7" x 7"	4.2	28 3/4"	28
Wide Mouth™ – Stainless Steel housing				
5 6054 0010	8" OD / 9" x 8 1/2"	4.2	30 3/4"	35.6

Contact CS Unitec for M42 Cobalt Steel SuperBand™ band saw blades

Optional blade guards available for CS Unitec Band Saws



Vise Clamps for Accurate Cuts

- Securely clamp to round, square and angular materials for straight cutting
- Easily attach to CS Unitec Portable Band Saws

Clamp-on vise for 4-3/4" Band Saws

Model No. 5 6030 9000

(for saw 5 6043 0010)

Max. material size – rounds: 4 3/4"; squares: 4 1/2"; angles: 4 1/2"

Clamp-on vise for 7" Deep Throat™ Band Saws

Model No. 5 6031 9400

(for saw 5 6031 0010 N and 5 6041 0010)

Max. material size – rounds: 7"; squares: 5"; angles: 5"



Caution: User must follow all appropriate safety regulations when choosing a tool for their particular working environment.

Underwater and Specialty Tools - Hydraulic & Air

Pipe Cutting Machines - Cut pipe up to 96" dia.



ATEX Certified

Air and hydraulic models – ideal for use in municipal water and gas utilities, petrochemical, power generation, plant maintenance, pipe line construction, marine and demolition applications.

- Use on steel, ductile iron, nonferrous metal, HDPE, plastic, concrete pipe and more
- Cut pipe underground with minimal excavation
- Machine is manually guided with hand lever feed to make a 360° cut in pipe at 90°
- Guide chain is adjustable by adding and removing chain links
- ATEX certified for use in Ex Zones (ATEX II 2 GcT6)



**Hydraulic Model
No. 5 8006 7000**

**Pneumatic Model
No. 5 8010 0050**

Features include:

- Quickly cut pipe from 6" to 96" dia. with wall thicknesses from 1/4" to 2"
- 7" blade with adjustable cutting depth and fully enclosed blade guard
- Fully enclosed blade guard
- Cooling water connection
- Carbide-tipped or diamond-coated blades

Visit www.csunitec.com for saw blades and accessories

When ordering, specify pipe diameter and application for assistance with determining required blade, feed handle, guide carriage & chain and tensioning chain & tensioner.



Model No.	Motor Specifications	Blade Arbor	Speed (RPM)	Blade Dia.	Hose Connection	Weight
Pneumatic Motor						
5 8002 7000	2.4 HP, 77 CFM @ 90 PSI	7/8"	350/1800	7"	1/2" NPT	28 lbs.
5 8010 0050	4 HP, 106 CFM @ 90 PSI	7/8"	1800	7"	3/4" NPT	28 lbs.
Hydraulic Motor						
5 8006 7000	4 HP, 6-13 GPM @ 2000 PSI	7/8"	350/1800	7"	1/2" FF (HTMA)	28 lbs.

Pneumatic Pipe Cutting Kits

Select Appropriate Kit Based on Pipe Diameter For cutting pipe with diameter greater than 63", please contact CS Unitec for help identifying necessary components.

Pipes 6" to 16" (150-400mm)		Pipes 6" to 32" (150-800mm)		Pipes 6" to 63" (150-1600mm)	
P/N Kit 5 8010 16PK includes:		P/N Kit 5 8010 32PK includes:		P/N Kit 5 8010 63PK includes:	
Qty.	Item	Qty.	Item	Qty.	Item
1	Motor P/N 5 8010 0050	1	Motor P/N 5 8010 0050	1	Motor P/N 5 8010 0050
1	Guide Carriage, small P/N 5 8010 8090	1	Guide Carriage, small P/N 5 8010 8090	2	Guide Carriage, small P/N 5 8010 8090
1	Chain Tensioner, small P/N 5 8003 8300	1	Chain Tensioner, small P/N 5 8003 8300	1	Chain Tensioner, small P/N 5 8003 8300
1	Guide Chain, 16" OD (24 chain links) P/N 5 8002 8760	1	Guide Carriage, large P/N 5 8010 8100	2	Guide Carriage, large P/N 5 8010 8100
1	7" Dia. Carbide-tipped blade P/N 9 2503 0120	1	Chain Tensioner, large P/N 5 8002 8400	2	Chain Tensioner, large P/N 5 8002 8400
1	7" Dia. Diamond blade P/N 9 2503 0100	1	Tensioning Chain P/N 5 8002 8710	2	Tensioning Chain P/N 5 8002 8710
1	Tool Kit P/N 5 8002 9200	1	Guide Chain, 32" OD (46 chain links) P/N 5 8002 8780	1	Guide Chain, 63" OD (90 chain links) P/N 5 8002 8830
1	Steel Transport Box P/N 5 8002 9300	1	7" Dia. Carbide-tipped blade P/N 9 2503 0120	1	7" Dia. Carbide-tipped blade P/N 9 2503 0120
		1	7" Dia. Diamond blade P/N 9 2503 0100	1	7" Dia. Diamond blade P/N 9 2503 0100
		1	Tool Kit P/N 5 8002 9200	1	Tool Kit P/N 5 8002 9200
		1	Steel Transport Box P/N 5 8002 9300	1	Steel Transport Box P/N 5 8002 9300



Caution: User must follow all appropriate safety regulations when choosing a tool for their particular working environment.

Underwater and Specialty Tools - Hydraulic & Air

Ideal for Industrial, Subsea, Mining, Utility, Demolition and Construction applications, including Ex Zones and Hazardous Environments



Air Chain Saws for Hazardous Atmospheres and Wet Environments

Chain brake for operator safety

- Pneumatic power for use in hazardous atmospheres and wet environments, including underwater applications
- Chain brake for stopping chain movement during kickback or repositioning of saw during cutting
- Powerful 4 HP motor at 90 PSI air pressure, 92 CFM
- Low maintenance and easy startup – saw chain and motor are automatically oiled by two separate lubricating systems
- .404 pitch Super Chisel saw chain is standard
- Optional carbide-tipped and ripping chain available



Pipe clamp for straight cutting of HDPE and plastic pipe. For use with 5 1027 series. P/N 5 1027 9100



Series 5 1026, 5 1027, 5 1028 and 5 1029 Pneumatic chain saw with brake

11", 17", 21" and 25" cutting capacity options

Model No.	Power	Cutting Capacity	Length with Bar	Weight	Air Connection	Hose ID
For Underwater Use, with brake - depths up to 33 ft. (10 meters)						
5 1028 0010	4 HP, 90 PSI @ 92 CFM	17"	33"	25 lbs.	3/4" NPT (ID)	5/8"
5 1028 0020	4 HP, 90 PSI @ 92 CFM	21"	37"	28 lbs.	3/4" NPT (ID)	5/8"
5 1028 0040	4 HP, 90 PSI @ 92 CFM	25"	41"	31 lbs.	3/4" NPT (ID)	5/8"
For Cutting Plastic, with brake and water feed system						
5 1027 0010	4 HP, 90 PSI @ 92 CFM	17"	33"	25 lbs.	3/4" NPT (ID)	5/8"
5 1027 0020	4 HP, 90 PSI @ 92 CFM	21"	37"	28 lbs.	3/4" NPT (ID)	5/8"
5 1027 0040	4 HP, 90 PSI @ 92 CFM	25"	41"	31 lbs.	3/4" NPT (ID)	5/8"
5 1027 9100	Pipe clamp for straight cutting of plastic					
For Cutting Wood, with brake						
5 1026 0010	4 HP, 90 PSI @ 92 CFM	17"	33"	25 lbs.	3/4" NPT (ID)	5/8"
5 1026 0020	4 HP, 90 PSI @ 92 CFM	21"	37"	28 lbs.	3/4" NPT (ID)	5/8"
5 1026 0040	4 HP, 90 PSI @ 92 CFM	25"	41"	31 lbs.	3/4" NPT (ID)	5/8"
For Underground/Coal Mining Use, with brake						
5 1029 0010	4 HP, 90 PSI @ 92 CFM	17"	33"	25 lbs.	3/4" NPT (ID)	5/8"
5 1029 0020	4 HP, 90 PSI @ 92 CFM	21"	37"	28 lbs.	3/4" NPT (ID)	5/8"
5 1029 0040	4 HP, 90 PSI @ 92 CFM	25"	41"	31 lbs.	3/4" NPT (ID)	5/8"

Chain Saw Chains and Bars

Other lengths available. Contact CS Unitec for more information.

Standard Saw Chain

Model No.	Description
5 1005 9910	10"
5 1007 9915	15"
5 1007 9930	17"
5 1007 9935	21"
5 1007 9940	25"



Armor Tip Chain Saw Bars

Model No.	Description
5 1005 7160	11" Bar
5 1005 7115	15" Bar
5 1005 7120	17" Bar
5 1005 7130	21" Bar
5 1007 7140	25" Bar



Ripping Saw Chain

Model No.	Description
5 1007 93BR	15" (for cutting polyethylene and plastics)
5 1007 96BR	17" (for cutting polyethylene and plastics)
5 1007 98BR	21" (for cutting polyethylene and plastics)
5 1007 99BR	25" (for cutting polyethylene and plastics)

Carbide-Tipped Saw Chain

Model No.	Description
5 1005 CC10	10"
5 1007 CC15	15"
5 1007 CC20	17"
5 1007 CC40	21"
5 1007 CC60	25"
5 1007 CCBK	Bulk (100 ft.). For 5 1007 series models

Carbide-Tipped Saw Chain for ACH Models

Model No.	Description
5 1005 CC12	12" for model ACH000-12
5 1005 CC14	14" for model ACH000-14
5 1005 CC16	16" for model ACH000-16

Caution: User must follow all appropriate safety regulations when choosing a tool for their particular working environment.

Underwater and Specialty Tools - Hydraulic & Air

Air Chain Saws for Hazardous Atmospheres and Wet Environments

Low maintenance and easy startup

- Pneumatic power for use in hazardous atmospheres and wet environments, including underwater applications
- Chain guard to protect operator
- Powerful 4 HP motor
- Saw chain and motor are automatically oiled by two separate lubricating systems
- .404 pitch Super Chisel saw chain is standard
- Optional carbide-tipped and ripping chain available



Series 5 1008:
Underwater chain saw
with exhaust valve



*Air Tool Line
Conditioner for
underwater air tools
to displace moisture.
Inhibits rust and
corrosion of air motors.
5 liters. Order P/N
9109.*

Model No.	Power	Cutting Capacity	Length w/ Bar	Weight	Air Connection	Hose ID
For Underwater Use*						
5 1008 0030	4 HP, 90 PSI @ 92 CFM	21"	37"	29 lbs.	3/4" NPT (ID)	5/8"
5 1008 0040	4 HP, 90 PSI @ 92 CFM	25"	41"	31 lbs.	3/4" NPT (ID)	5/8"
For General Use						
5 1007 0003	4 HP, 90 PSI @ 92 CFM	15"	29"	22 lbs.	3/4" NPT (ID)	5/8"
5 1007 0010	4 HP, 90 PSI @ 92 CFM	17"	33"	25 lbs.	3/4" NPT (ID)	5/8"
5 1007 0020	4 HP, 90 PSI @ 92 CFM	21"	37"	28 lbs.	3/4" NPT (ID)	5/8"
5 1007 0040	4 HP, 90 PSI @ 92 CFM	25"	41"	31 lbs.	3/4" NPT (ID)	5/8"



Hydraulic Chain Saw with Brake

Ideal for Industrial, Subsea, Mining, Utility, Demolition and Construction applications, including Ex Zones and Hazardous Environments



ATEX Certified



- Hydraulic power: safe use in wet environments and underwater applications
- Chain brake for stopping chain movement during kickback
- Open center hydraulic system with integrated pressure control
- Powerful 10 HP motor operates at 12 GPM at 2000 PSI
- Standard with .404 pitch Super Chisel saw chain
- Optional carbide-tipped saw chain available

Model No.	Power	Cutting Capacity	No-Load Speed	Hose ID
5 1030 0002	10 HP, 12 GPM @ 2000 PSI	11"	5000 RPM	5/8"
5 1030 0300	10 HP, 12 GPM @ 2000 PSI	15"	5000 RPM	5/8"
5 1030 0010 N	10 HP, 12 GPM @ 2000 PSI	17"	5000 RPM	5/8"
5 1030 0020 N	10 HP, 12 GPM @ 2000 PSI	21"	5000 RPM	5/8"
5 1030 0040 N	10 HP, 12 GPM @ 2000 PSI	25"	5000 RPM	5/8"
5 1030 0060	10 HP, 12 GPM @ 2000 PSI	28"	5000 RPM	5/8"
5 1030 0070	10 HP, 12 GPM @ 2000 PSI	40"	5000 RPM	5/8"

* Includes whip hose with 1/2" FF couplings



Optional Splash Guard
P/N 5 1030 9100



**Clamp for cutting
up to 27" pipe**
P/N 5 1030 9300

Utility Pneumatic Chain Saw

- Ideal all-purpose air chain saw – compact, lightweight and powerful
- Only 5.4 lbs., 10" capacity
- Ideal for utilities, mines, construction and agriculture



Model 5 1005 0010 – 10" cutting capacity
Includes built-in chain oiler and chain brake

Model 5 1005 0010

Power	1.2 HP 90 PSI @ 30 CFM
Cutting Capacity	10"
Length	21"
Weight	5.4 lbs.
Air Connection	1/4" NPT (ID)
10" Armor Tip Bar, order p/n 5 1005 7111	
Standard Saw Chain, order p/n 5 1005 9910	
Carbide-Tipped Chain, order p/n 5 1005 CC10	

Caution: User must follow all appropriate safety regulations when choosing a tool for their particular working environment.

Underwater and Specialty Tools - Hydraulic & Air

Ideal for Industrial, Subsea, Mining, Utility, Demolition and Construction applications, including Ex Zones and Hazardous Environments

Portable Magnetic Drills – Pneumatic

Holes up to 2-1/16" dia.



- Inherently safer than electromagnetic drills in hazardous atmospheres and wet environments where electricity requires "hot work permits"
- Industry's first completely air-operated magnetic drill –NO ELECTRICITY!
- Fail-safe permanent magnetic is activated "on" and "off" by air pressure; if air flow is lost, the magnet will not disengage
- Long drill stroke –up to 10-1/4"
- Pressurized coolant system lubricates cutter and reduces risk of sparking

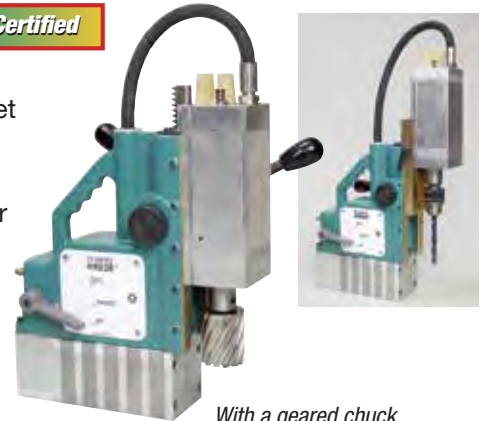

Model AB-4300-2 / AB-4300-2R Specifications	
Motor Power	1.6 HP, 64 CFM @ 90 PSI
Hole Capacity	2 1/16" dia.
No Load Speed	400 RPM
Magnetic Force (1" plate)	1600 lbs.
Arbor Bore	3/4" Weldon Shank
Automatic Lubrication	Included

Drill with 4-7/8" stroke:
Order Model AB-4300-2

Drill with 10-1/4" stroke:
Order Model AB-4300-2R



With a geared chuck adapter (Part No. IBC 18) and extra rack (Model No. AB-4300-2R), AIRBOR™ easily converts to a standard drill press with a 7 1/2" stroke.

Visit www.csunitec.com for annular cutters and accessories

Portable Magnetic Drills – Hydraulic

Holes up to 4" dia., tap up to 1" dia.

- Hydraulic motor safe for underwater use
- Ideal for industrial, construction, marine and mining applications
- Drill structural steel and other metals
- Manually operated permanent magnet with ratchet control



Model HB 4400	
Motor Power	1.5 HP, 4.5 GPM @ 2000 PSI
Hole Capacity	2 1/16" dia.
No Load Speed, var.	0-630 RPM
Magnetic Force (1" plate)	1300 lbs.
Arbor Bore	3/4" Weldon Shank
Automatic Lubrication	Included



Drill with Wide Base:
Order Model 2 1345 0020

Drill with Standard Base:
Order Model 2 1345 0010



Models 2 1345 0020 and 2 1345 0010	
Motor Power	3.4 HP, 4.3 GPM @ 2000 PSI
Stroke	12"
Hole Capacity	4" dia.
Tapping Capacity	1" dia.
No Load Speed, var.	40-250 RPM
Magnetic Base Size	12-4/5" L x 7-1/2" W (2 1345 0020) 11-11/16" L x 4" W (2 1345 0010)
Magnetic Force (1" plate)	3306 lbs. (2 1345 0020) 1874 lbs. (2 1345 0010)
Arbor Bore	3/4" Weldon Shank
Spindle	MT3
ATEX Certification	II2GExhIIBT5Gb
Automatic Lubrication	Included



Pipe Clamp – Model 2 1330 8500

Optional clamp allows right angle drilling of steel, cast iron, cement and plastic pipes up to 19-1/2" dia.



Extension chains available for pipes up to 43-1/4" dia.
P/N 5 1201 9030* – For pipes up to 31-1/2" (800mm)
P/N 5 1201 9020* – For pipes up to 43-1/4" (1100mm)
* 2 pieces needed for one clamp

Caution: User must follow all appropriate safety regulations when choosing a tool for their particular working environment.

Underwater and Specialty Tools - Hydraulic & Air

Rotary Hammer Drills – Pneumatic and Hydraulic

Powerful percussion drilling for concrete and masonry

- SDS Plus or SDS Max models
- Safety clutch protects against overloading and jamming
- Hammer drill holes in concrete, brick and masonry
- Rotary drilling mode for straight drilling of steel and wood
- Open center hydraulic standard, closed center optional

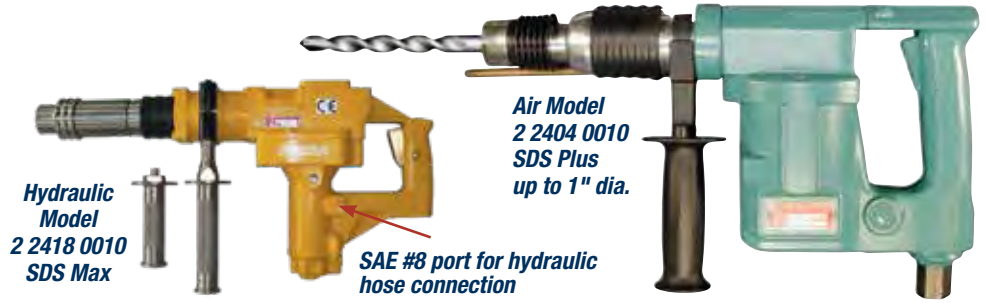

ATEX



1/2" chuck with SDS+ shank: Part No. 2 2409 8999
 1/2" chuck with SDS Max shank: Part No. XRDCMKL 12

Pneumatic Hammer Drill Model No.	Blows/Minute (BPM)	Drill Speed (RPM)	Solid Bit Capacity (concrete)	Core Bit Capacity (concrete)	Twist Drill (wood)	Motor Power (HP)	CFM at 90 PSI	Tool System	Weight (lbs.)
2 1266 0010	0-2000	0-950	1/2" dia.	1" dia.	3/8" dia.	0.75	21	1/2" Chuck	7
2 2404 0030*	0-3000	0-625	1" dia.	3" dia.	3/4" dia.	0.70	21	SDS Plus	11
2 2417 0010	0-2500	0-250	2" dia.	6" dia.	1 1/4" dia.	1.60	53	SDS Max	26

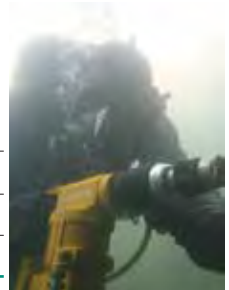

* Underwater model with exhaust valve port pointing away from user's work area and line of sight. Optional underwater air tool line conditioner to displace moisture, Part No. 9109 (5 liters).

Hydraulic Hammer Drill Model No.	Blows/Minute (BPM)	Drill Speed (RPM)	Solid Bit Capacity (concrete)	Core Bit Capacity (concrete)	Twist Drill (wood)	Motor Power (HP)	Oil Flow @ 1160 PSI	Tool System	Weight (lbs.)
2 2426 0010**	0-3400	0-625	1" dia.	3" dia.	3/4" dia.	0.8	5.8-13.2 GPM	SDS Plus	15
2 2418 0010	0-2500	0-250	2" dia.	6" dia.	1 1/4" dia.	1.8	2.6-13.2 GPM	SDS Max	11
2 2418 0020	Same as 2 2418 0010 above. Includes 2 2406 9700 Pressure Reducing Valve for 2000 PSI.								

Hydraulic Hammer Drills operate at hydraulic pressures of 1160 PSI max. Pressure reducing valves are available to reduce pressure from 2000 PSI or 5000 PSI. Available with optional closed center. Hydraulic Hammer Drills supplied with whip hoses and flush face couplers.

** Pressure relief valve is built into the handle

Woodboring Drills

Heavy-duty power for drilling wood in marine timbers, underwater use and railroad repair work

- Thrust bearing support for long life and efficient operation
- Lever throttle and durable spur gearing
- Breast plate and dead handle included
- Includes 1/2" NPT threaded exhaust port
- Recommended hose size: 1/2"
- 1/2" ID air inlet thread
- Use underwater with Air Tool Line Conditioner



Accessories and woodboring drill bits from 1/2" dia. to 1 1/2" dia. in lengths from 12" to 36"



Specifications	Model 2 1903 0010	Model 2 1924 0010	Model 2 1932 0010 N
Capacity in Wood	1" Diameter	2" Diameter	3" Diameter
Motor Power	2 HP	3 HP	3 HP
Air Consumption: 39 CFM @ 90 PSI			
Chuck Style	1/2" Woodboring	1/2" Woodboring	1/2" Woodboring
Spindle	Stub Taper	#2 Morse Taper	#3 Morse Taper
Free Speed	750 RPM	700 RPM	380 RPM
Weight	14 1/2" lbs.	24 3/4" lbs.	24 3/4" lbs.
Optional Geared Drill Chuck	Part No. DE-99C	Part No. IBC 22 (MT2)	Part No. IBC 21 (MT3)

Caution: User must follow all appropriate safety regulations when choosing a tool for their particular working environment.

Circular Saws – Pneumatic

7-1/2" dia. Heavy-Duty Air Circular Saw

Cut up to 2-1/2" depth at 90° and 1-1/2" at 45°

Air power ideal for petrochemical, marine, demolition and fabrication industries



1.7 HP
Air Motor

- Heavy-duty, ideal for wet and dirty conditions
- Pneumatic power eliminates burn out from stalls
- 7-1/2" max. blade capacity
- D-handle design with inside trigger and safety lock to prevent accidental starting



Carbide-Tipped Blade for General Use, 7" dia. (180MM)
P/N 9 2503 0120 36T, to cut metal, plastics and wood.



Diamond Blade for Concrete, 7" dia. (180MM)
P/N 37443000, to cut concrete and masonry.

7-1/2" dia. Heavy-Duty Air Circular Saw

Order No.	5 1116 0020
Motor Power	1.7 HP (1.3 kW)
Blade Diameter	7-1/2" (190mm)
Max. Depth of Cut	2-1/2" at 90° / 1-1/2" at 45°
Speed (Free)	3,200 RPM
Air Consumption	53 CFM at 90 PSI
Air Connection	1/2" NPT
Vibration	<2.5 m/s ²
Length, Weight	13-1/2", 19 lbs.

* Model 5 1116 0020 also accepts 7-1/4" dia. blades
Standard equipment includes rip fence and blade wrench. Blade not included.

9" dia. Air Circular Saw for 90° and 45° Cuts

Dry cut up to 3-1/4" depth and 3/8" thick steel plate



ATEX Certified



2 HP Air Motor

- Cut steel, nonferrous metal, plastic, grating, composite and corrugated materials
- Cuts at 90° and 45° angles
- Ideal for petrochemical, marine, demolition and fabrication applications



9" dia. Air Circular Saw for 90° & 45° Cuts

Order No.	5 1115 0020 N
Motor Power	2 HP (1.5 kW)
Blade Diameter	9"
Max. Depth of Cut	3-1/4" at 90° / 2-1/8" at 45°
Speed (Free)	1,700 RPM
Air Consumption	71 CFM at 90 PSI
Air Connection	1/2" NPT
Vibration	<2.5 m/s ²
Weight	19 lbs.

Standard equipment includes an impact-resistant carrying case and Ultra-Thin LBS blade (P/N 722-23060).

Dry Cutting TCT Saw Blades



Part No.	Teeth	Thickness
722-23060*	60	.055"

* Standard with Model 5 1115 0020 Pneumatic Metal Saw.

Tungsten Carbide-Tipped Dry Cutting Blades, 9" dia., .073" thick for Model 5 1115 0020

P/N 721-23048, 48T, for standard use
P/N 721-23060, 60T, for aluminum

P/N 721-23068, 68T, for thin-wall metal
P/N 721-23084, 84T, for sheet metal

12-5/8" dia. Air Circular Saw for 90° and 45° Cuts

Cut I-beams, 3/8" thick steel plate, insulation boards, sandwich panels, aluminum, plastics and more

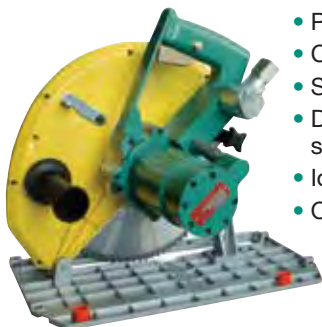

- Powerful 2.4 HP motor for demanding applications
- Cuts 3/8" thick steel plate and up to 4-3/4" in other materials
- Suction nozzle and internal chip collector
- D-handle design with inside trigger and safety lock to prevent accidental starting
- Ideal for steel construction, demolition and more
- Optional guide rail with clamping system (p/n 608275 SET)



Carbide-Tipped Blades for General Use

Part No. 608276 (included): 12-5/8", 84T, for metal, plastics and wood
Part No. 608276SI: 12-5/8", 84T, for stainless steel - blade specially coated, increasing cutting life by 2.5X

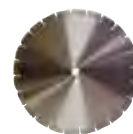

Diamond Blade for Concrete

Part No. 734906: 12", Diamond blade for cutting concrete and masonry

12-5/8" dia. Air Circular Saw

Order No.	5 1117 0020 N
Motor Power	2.4 HP (1.8 kW)
Blade Diameter	12-5/8"
Max. Depth of Cut	4-3/4" (steel) 4" (concrete)
Speed (Free)	1,200 RPM
Air Consumption	71 CFM at 90 PSI
Air Connection	1/2" NPT
Vibration	<2.5 m/s ²
Weight	24 lbs.

Caution: User must follow all appropriate safety regulations when choosing a tool for their particular working environment.

Circular Saws – Hydraulic



ATEX Certified



7-1/2" dia. Heavy-Duty Hydraulic Circular Saw for Concrete and Metal

ATEX Certified - Ideal for use in EX Zones and underwater applications



Designed for underwater/subsea use, this heavy-duty hydraulic circular saw can also be used in standard cutting applications. The 5 1128 0010 uses up to 7-1/2" blades for cutting concrete and metal, with a maximum 2-1/2" depth of cut. With miter capability up to 45° this saw can be used for a wide range of cutting applications.

- Ideal for marine and underwater environments
- Cuts up to 2-1/2" depth at 90° and 1-1/2" depth at 45°
- D-handle design with inside trigger and safety lock to prevent accidental starting



7-1/2" dia. Heavy-Duty Circular Saw

Order No.	5 1128 0010
Motor	3.1 HP (2.3 kW), 5.25 GPM at 2000 PSI
Blade Diameter	7-1/2" (190mm)
Max. Depth of Cut	2-1/2" at 90° / 1-1/2" at 45°
Speed (Free)	3,200 RPM
Arbor Size	5/8", 3/4", 1.2" (16, 19, 20, 30 mm)
Couplings	1/2" FF (HTMA)
Vibration	<2.5 m/s ²
Weight	22.5 lbs.



Carbide-Tipped Blade for General Use, 7" dia. (180MM)

P/N 9 2503 0120 36T, to cut metal, plastics and wood.



Diamond Blade for Concrete, 7" dia. (180MM)

P/N 37443000, to cut concrete and masonry.

* Model 5 1128 0010 saw also accepts 7-1/4" dia. blades. Standard Equipment includes rip fence and blade wrench. (Note: blade not included)

12-5/8" dia. Heavy-Duty Hydraulic Circular Saw for Concrete and Metal

ATEX Certified - Ideal for use in EX Zones and underwater applications



ATEX Certified



Designed for underwater/subsea use, this heavy-duty hydraulic circular saw can also be used in standard cutting applications. The 5 1127 0010 circular saw uses up to 12-5/8" blades for cutting concrete and metal, with a maximum 4-3/4" depth of cut. Ideal for a wide range of cutting applications from cutting I-beams, 3/8" thick steel plate, insulation boards, sandwich panels, aluminum, plastics and more.

- Ideal for marine and underwater environments
- 4-3/4" Max. depth of cut
- D-handle design with inside trigger and safety lock button to prevent accidental starting



12-5/8" dia. Heavy-Duty Circular Saw

Order No.	5 1127 0010
Motor	3.1 HP (2.3 kW), 5.25 to 6 GPM at 2000 PSI
Blade Diameter	12-5/8" (320mm)
Max. Depth of Cut	4-3/4" (steel) 4" (concrete)
Speed (Free)	1,800 RPM
Arbor Size	1" (25.4 mm)
Couplings	1/2" FF (HTMA)
Vibration	<2.5 m/s ²
Weight	27 lbs.

Standard equipment includes a saw blade (Part No. 608276).



Carbide-Tipped Blades for General Use

Part No. 608276: 12-5/8", 84T, for cutting metal, plastics and wood

Part No. 608276SI: 12-5/8", 84T, for stainless steel - blade specially coated, increasing cutting life by 2.5X

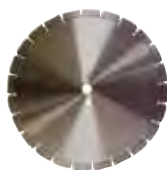

Diamond Blade for Concrete

Part No. 734906: 12", Diamond blade for cutting concrete and masonry

Caution: User must follow all appropriate safety regulations when choosing a tool for their particular working environment.

Underwater and Specialty Tools - Hydraulic & Air

Ideal for Industrial, Subsea, Mining, Utility, Demolition and Construction applications, including Ex Zones and Hazardous Environments

Diamond Core Drills - Hydraulic and Pneumatic

Drill holes up to 12" in concrete, reinforced concrete and asphalt

- Rugged 3-speed gearbox with mechanical slip clutch
- Ideal for heavy-duty drilling in wet and underwater environments

See page 27 for more information



Model 2 1317 0030



Hydraulic Core Drill Model No.	Motor Power	Max. Drilling	Speed (RPM)	Oil Flow/ 2000 PSI	Weight (lbs.)	Stand
2 1317 0030	3.6 HP	3" dia.	380/900/ 1800	6 GPM	16	Motor only
2 1317 0030 SA	3.6 HP	6" dia.			47	Anchor Stand
2 1317 0030 SV	3.6 HP	6" dia.			49	Anchor Stand & Vacuum Pump
2 1327 0010 SA	4.2 HP	12" dia.	380/900/ 1800	6 GPM	69	Anchor Stand
2 1327 0010 SV	4.2 HP	12" dia.			82	Anchor Stand & Vacuum Pump

Note: Hand-held core drills are intended up to a max. of 3" dia. for hand-held drilling or up to 6" dia. with a stand.

Pneumatic Core Drill Model No.	Motor Power	Max. Drilling	Speed (RPM)	CFM @ 90 PSI	Weight (lbs.)	Stand
2 1333 0010	2.1 HP	3" dia.	400/900/ 1600	77	18	Motor only
2 1333 0010 SA	2.1 HP	6" dia.			49	Anchor Stand
2 1333 0010 SV	2.1 HP	6" dia.			51	Anchor Stand & Vacuum Pump
2 1335 0010	3.8 HP	3" dia.	300/700/ 1350	123	21	Motor only
2 1335 0010 SA	3.8 HP	6" dia.			52	Anchor Stand
2 1335 0010 SV	3.8 HP	6" dia.			54	Anchor Stand & Vacuum Pump
2 1328 0050 SA	3.8 HP	12" dia.	300/700/ 1350	123	66	Anchor Stand
2 1328 0050 SV	3.8 HP	12" dia.			72	Anchor Stand & Vacuum Pump

Note: Hand-held core drills are intended up to a max. of 3" dia. for hand-held drilling or up to 6" dia. with a stand.



Model 2 1328 0050 SA

ATEX Certified

For use in hazardous environments and ATEX and Ex Zones

Impact Wrenches - Pneumatic and Hydraulic

Ideal for tightening and removing bolts and screws up to 1-1/8"

- Applications include industrial, mining, assembly and subsea
- High torque, best power-to-weight ratio



6 1520 0010
1" Hydraulic Impact Wrench
1840 ft.-lbs. torque



Non-Sparking Impact Sockets also available

6 1515 0010
3/4" Hydraulic Impact Wrench
1220 ft.-lbs. torque



Pneumatic Impact Wrench Model No.	Description	Max. Bolt Size	Tightening Torque (Hard)	Weight
6 1316 0070	3/4" Square Drive	1-1/8" (M 30)	995 ft.-lbs.	12.3 lbs.
6 1316 0060	1" Square Drive	1-1/8" (M 30)	995 ft.-lbs.	13.6 lbs.

Hydraulic Impact Wrench Model No.	Description	Max. Bolt Size	Tightening Torque (Hard)	Weight
6 1515 0010	3/4" Square Drive	1" (M 27)	1220 ft.-lbs.	18.1 lbs.
6 1520 0010	1" Square Drive	1-3/8" (M 36)	1840 ft.-lbs.	25.0 lbs.



Caution: User must follow all appropriate safety regulations when choosing a tool for their particular working environment.

Underwater and Specialty Tools - Hydraulic & Air

Underwater Hydraulic Angle Grinder

Works with grinding wheels up to 7" dia.

- For use with a variety of wheels, brushes and attachments
- 5,500 RPM at 5.25 GPM



Model 1 1585 0010

Motor Power	1.3 HP
Speed	5500 RPM
Weight	16.72 lbs.
Throttle Type	Lever
Grinding Wheels	Up to 7"

Underwater Hydraulic Horizontal Grinder

Fits grinding discs up to 7-3/4" dia.

- Safety lever control with starting lock for improved user safety
- 7,000 RPM at 5 GPM
- Extensions available up to 19"
- Works with straight grinding wheels, carbide burrs, wire brushes, cones and plugs



Model 1 1580 0060 N

Motor Power	1.3 HP
Speed	7000 RPM
Weight	18.25 lbs.
Throttle Type	Lever
Grinding Wheels	Straight Type

Includes 5/8" x 11 adapter (1 1580 9060) and flange (1 1307 8030) for adapting to different grinding wheel types

Underwater Hydraulic Peanut Die Grinder

Works with cutting wheels up to 4" dia. and carbide burrs

- Safety lever control with starting lock for improved user safety
- 11,500 RPM with flow range from 2.6 to 7.9 GPM



Model 1 5080 0020

Motor Power	1.0 HP
Speed	11,500 RPM
Weight (without hoses)	3.5 lbs.
Throttle Type	Lever
Collet	1/4"
Pressure Relief	2000 PSI (140 bar)

Underwater Hydraulic Vertical Grinder

For grinding discs up to 9" dia.

- Wide safety lever control with starting lock for improved user safety
- Protective shroud rotates 360°
- 3,600 RPM at 12 GPM
- Ergonomic primary handle and removable second handle for added stability



Model 1 2060 0010

Motor Power	4.75 HP
Speed	3,600 RPM
Weight	12.75 lbs.
Throttle Type	Lever
Grinding Wheels	Up to 9"
Connections	3/4" - 16 UNF

Power Packs

Hydraulic Power Unit

Model P95

- Ideal for use with our hydraulic power tools
- Delivers 5 GPM or 8 GPM at 2000 PSI
- Easy to move with lift and latch handle
- Weighs 330 lbs.
- 18 HP gas engine



Hydraulic Power Unit is available with gas, electric or diesel engines. Contact us for more information.

AirPac Dryer/Cleaner

Model CSAP-2

- Removes moisture and dirt from air lines; float valve automatically ejects water and dirt
- Includes automatic oiler; protects tools from freezing in cold environments
- Eliminates air motor downtime caused by water and dirt
- Connections for two tools; max. air flow 185 CFM



Air Tool Lubricant

*ProLube-ATL
P/N CS 7043-001 (gallon)*

Air Tool Lubricant with Anti-Freeze

*ProLube-ATL/AF
P/N CS 7049-001 (gallon)*

Air Tool Line Conditioner/Cleaner

For use in underwater air tools – displaces moisture and inhibits rust and corrosion of air motors – P/N 9109 (5 liters)

Service Unit / Lubricator / Regulator

Model 9 2406 0630 (1/2" NPT)

Model 9 2406 0650 (3/4" NPT)

- Portable filter, pressure regulator and lubricator
- Maintains constant downstream pressure for consistent tool operation
- Air pressure adjustable from 0-140 PSI
- Filter collects condensate, scale, rust, etc.
- Maximum air volume: 125 CFM
- Durable steel enclosure protects the unit



Also Available from CS Unitec

CS Unitec, Inc. specializes in industrial power tools and safety tools for construction and industry.

Innovation and high quality are synonymous with CS Unitec's power tools. In 1991, the company invented the first pneumatic portable band saw. CS Unitec has added to its list of industry firsts with the widest range of portable magnetic drills and hand-held concrete core drills. The line also includes surface preparation tools for metal, concrete and masonry, air, electric and hydraulic portable band saws, reciprocating saws, hacksaws, nut runners, rotary hammer drills, rolling motors, non-sparking safety tools, portable mixers and dust extraction vacuum systems.

For tool specifications and ATEX and Ex Zone information, visit www.csunitec.com.

Call 1-800-700-5919 or 203-853-9522 to request any of the catalogs shown below.



Contractor Tools:
Surface Preparation Tools,
Concrete Grinders, Dust
Collection Systems, Diamond
Core Drills, Air Concrete Saws
and more



Metalworking Tools:
Surface Preparation Tools, Dust
Collection Systems, Dry Cutting
Portable Saws, Portable Magnetic
Drills, Bridge Reamers and more



Non-Sparking Hand Tools:
Non-Sparking Hand Tools
Power Tools for use in Ex Zones,
ATEX Zones and Hazardous
Environments



View demo videos at
www.csunitec.com



CS UNITEC, Inc. 22 Harbor Avenue, Norwalk, CT 06850
4330 Center St., Deer Park, TX 77536
Phone 800-700-5919 • 203-853-9522 • Fax 203-853-9921
Email info@csunitec.com • www.csunitec.com

 View product demonstrations
at www.csunitec.com.

ALL SPECIFICATIONS ARE SUBJECT TO CHANGE

© Copyright 2021, CS Unitec, Inc., 5-21-12.5M